



Montagehinweis
Mounting instruction
Instruction de montage
Indicación para el montaje

DE
EN → page 15
FR → page 20
ES → page 25



Ölwechselkit für ZF-Automatgetriebe 5HP/6HP

VORSICHT

Verbrennungsgefahr durch Kontakt mit heißem Öl.

Leichte bis mittelschwere Verletzung möglich.

- ⇒ Schutzbrille tragen.
- ⇒ Schutzhandschuhe tragen.
- ⇒ Schutzkleidung tragen.

HINWEIS

Sachschaden durch elektrostatische Entladung (ESD) möglich

- ⇒ ESD-Schutz beachten.
- ⇒ Kontakte nicht berühren.
- ⇒ Ableitfähige Arbeitskleidung tragen.
- ⇒ ESD-Transportschutz verwenden.
- ⇒ ESD-Schutzverpackung verwenden.



HINWEIS

Folgende Hinweise beachten, um eine Beschädigung des Getriebes zu vermeiden:

- Fahrzeug ohne Getriebeölfüllung **nicht** abschleppen. Angaben des Fahrzeugherstellers beachten.
- Zum Reinigen nur saubere, **fusselfreie** Lappen verwenden.
- Motor **nicht** starten, wenn kein Öl im Getriebe ist.
- Ausschließlich das für das jeweilige Getriebe vorgeschriebene **ZF-LifeguardFluid** verwenden (Tab. 1).
- Keine zusätzlichen Additive verwenden, da diese die chemische Zusammensetzung des Öls verändern.
- Den Ölstand des Getriebes genau nach Befüllvorschrift einstellen. Bei zu geringem Ölstand wird das Getriebe beschädigt. Bei zu hohem Ölstand tritt das überschüssige Öl bei Erwärmung durch den Überlauf aus dem Getriebe aus. Das austretende Öl kann sich an heißen Teilen (z. B. Auspuffanlage) entzünden.
- Anschraubreihenfolge einhalten (Abb. 1).
- Anziehdrehmomente beachten (Tab. 2 bis 14).

 Vor dem Ölwechsel:
Anleitung genau lesen. Prüfen, welche Variante (A/B/C) für den Ölwechsel gilt (Tab. 1).

 ZF Automatgetriebe sind mit speziell entwickelten teilsynthetischen Ölen befüllt. Bei sehr hohen Betriebstemperaturen altert das Öl schneller als unter normalen Bedingungen. Beispiele:

- Viele Fahrten mit hohen Geschwindigkeiten.
- Viele Fahrten mit Anhänger.
- Sportliches Fahren.

 Serviceinformation beachten:

- 50324 DE (Führungshülse Mechatronik für ZF-Automatgetriebe 6HP)
- 50638 DE (Dichtungssätze für ZF-Automatgetriebe 6HP)



Montagehinweis
Mounting instruction
Instruction de montage
Indicación para el montaje

DE
EN → page 15
FR → page 20
ES → page 25



Zuordnung der Ölwechselkits/Assignment of Oil change kits/Affectation des Kits de vidange d'huile/Correlación Kit de cambio de aceite

Kit	Getriebe/ Transmission/ Transmission/ Cajas de Cambio		Ölwanne/ Oil pan/ Carter d'huile/ Cárter de aceite		Öl/ Oil/ Huile/ Aceite	Variante ⁴⁾ / Version ⁴⁾ / Version ⁴⁾ / Variante ⁴⁾			Tab.
			①	②		ZF LifeguardFluid	A	B	
1060.298.070 ¹⁾ 1060.298.072 ²⁾	5HP19	Alpina	x		5	x			
		BMW	x		5	x			
1060.298.069 ¹⁾ 1060.298.073 ²⁾	5HP19 FL	Audi	x		5	x			
		Porsche	x		5	x			
		Skoda	x		5	x			
		Volkswagen	x		5	x			
	5HP19 FLA	Audi	x		5	x			
		Volkswagen	x		5	x			
1058.298.046 ¹⁾ 1058.298.048 ²⁾	5HP24	Alpina	x		5	x			
		BMW	x		5	x			
		Jaguar	x		5	x			
		Land Rover	x		5	x			
1058.298.047 ¹⁾ 1058.298.049 ²⁾	5HP24 A	Audi	x		5	x			
1055.298.037 ¹⁾ 1055.298.040 ²⁾	5HP30	Alpina	x		5	x			
		Aston Martin	x		5	x			
		Bentley	x		5	x			
		BMW	x		5	x			
		Rolls-Royce	x		5	x			
1071.298.033 ¹⁾ 1071.298.038 ²⁾	6HP19 / X	BMW		x	6			x	3
	6HP21 / X								
1071.298.027 ¹⁾ 1071.298.039 ²⁾	6HP19 A	Audi	x		8			x	4
		Volkswagen							
1068.298.062 ¹⁾ 1068.298.083 ²⁾	6HP26	BMW		x	6	x			5
		Ford		x	6	x			
		Hyundai		x	6	x			
		Jaguar		x	6	x			6
		Lincoln		x	6	x			
	6HP26 X	Alpina		x	6	x			
		Aston Martin		x	6	x			
		BMW		x	6	x			7
		Ford		x	6	x			
		Land Rover		x	6	x			8
	6HP28	Lincoln		x	6	x			
		Alpina ³⁾		x	6		x		
		BMW		x	6		x		9
		Jaguar ³⁾		x	6		x		
	6HP28 X	Wiesmann ³⁾		x	6		x		
		Alpina		x	6		x		
		BMW ³⁾		x	6		x		10
	6HP32	Land Rover		x	6		x		
		Bentley		x	6	x			
		BMW		x	6	x			11
		Rolls-Royce		x	6	x			



Montagehinweis
Mounting instruction
Instruction de montage
Indicación para el montaje

DE
EN → page 15
FR → page 20
ES → page 25



Zuordnung der Ölwechselkits/Assignment of Oil change kits/Affectation des Kits de vidange d'huile/Correlación Kit de cambio de aceite

Kit	Getriebe/ Transmission/ Transmission/ Cajas de Cambio		Ölwanne/ Oil pan/ Carter d'huile/ Cárter de aceite		Öl/ Oil/ Huile/ Aceite	Variante ⁴⁾ / Version ⁴⁾ / Version ⁴⁾ / Variante ⁴⁾			Tab.
			①	②		ZF LifeguardFluid	A	B	
1068.298.061 ¹⁾ 1068.298.084 ²⁾	6HP26 X	BMW	x		6	x			12
		Lincoln	x		6	x			12
	6HP32	BMW	x		6	x			12
1068.298.054 ¹⁾ 1068.298.085 ²⁾	6HP26 A61	Audi	x		6	x			13
		Bentley	x		6	x			13
1084.298.013 ¹⁾ 1084.298.014 ²⁾	6HP28 AF	Audi	x		8		x		14

Tab. 1: Zuordnung der Ölwechselkits/Assignment of Oil change kits/Affectation des Kits de vidange d'huile/Correlación Kit de cambio de aceite

- ① Metall
- ② Kunststoff

¹⁾ Ölwechselkit mit Öl

²⁾ Ölwechselkit ohne Öl

³⁾ Bei Ausführung mit Thermostatventil: Die Getriebeöltemperatur muss auf der Probefahrt nach dem Ölwechsel min. 75 °C erreichen (Thermostatventil öffnet). Nach der Probefahrt das Getriebe abkühlen lassen und bei 35 °C Öltemperatur den Ölstand erneut prüfen.

⁴⁾ Vorgehensweise für den Ölwechsel auswählen, siehe Ablaufplan Seite 6.

① Metal

② Plastic

¹⁾ Oil change kit with oil

²⁾ Oil change kit without oil

³⁾ Versions with thermostat valve: The transmission oil temperature must reach at least 75 °C during the test drive after an oil change (thermostat valve opens). After the test drive, allow the transmission to cool and check the oil level again at 35 °C oil temperature.

⁴⁾ Select oil change procedure, see flowchart on Page 18 .

① Métal

② Plastique

¹⁾ Kit de vidange d'huile avec huile

²⁾ Kit de vidange d'huile sans huile

³⁾ Versions avec valve thermostatique : la température de l'huile de boîte de vitesses doit atteindre lors de l'essai sur route après la vidange d'huile au moins 75 °C (valve thermostatique ouvre). Après l'essai sur toute, laisser refroidir la boîte de vitesses et de nouveau contrôler le niveau d'huile lorsque la température d'huile est de 35 °C.

⁴⁾ Choisir la démarche à adopter pour la vidange d'huile, voir la procédure page 23.

① Metal

② Material sintético

¹⁾ Kit de cambio de aceite con aceite

²⁾ Kit de cambio de aceite sin aceite

³⁾ Variantes con válvula termostato: la temperatura del aceite para la caja de cambios tiene que alcanzar durante la prueba en carretera después del cambio de aceite como mín. 75 °C (válvula termostato se abre). Después de la prueba en carretera, dejar enfriar la caja de cambios y volver a comprobar el nivel de aceite a una temperatura de aceite de 35 °C.

⁴⁾ Elegir como proceder para cambiar el aceite, véase la página 28 del plano de procedimiento.





Montagehinweis
Mounting instruction
Instruction de montage
Indicación para el montaje

DE → page 15
EN → page 20
FR → page 20
ES → page 25

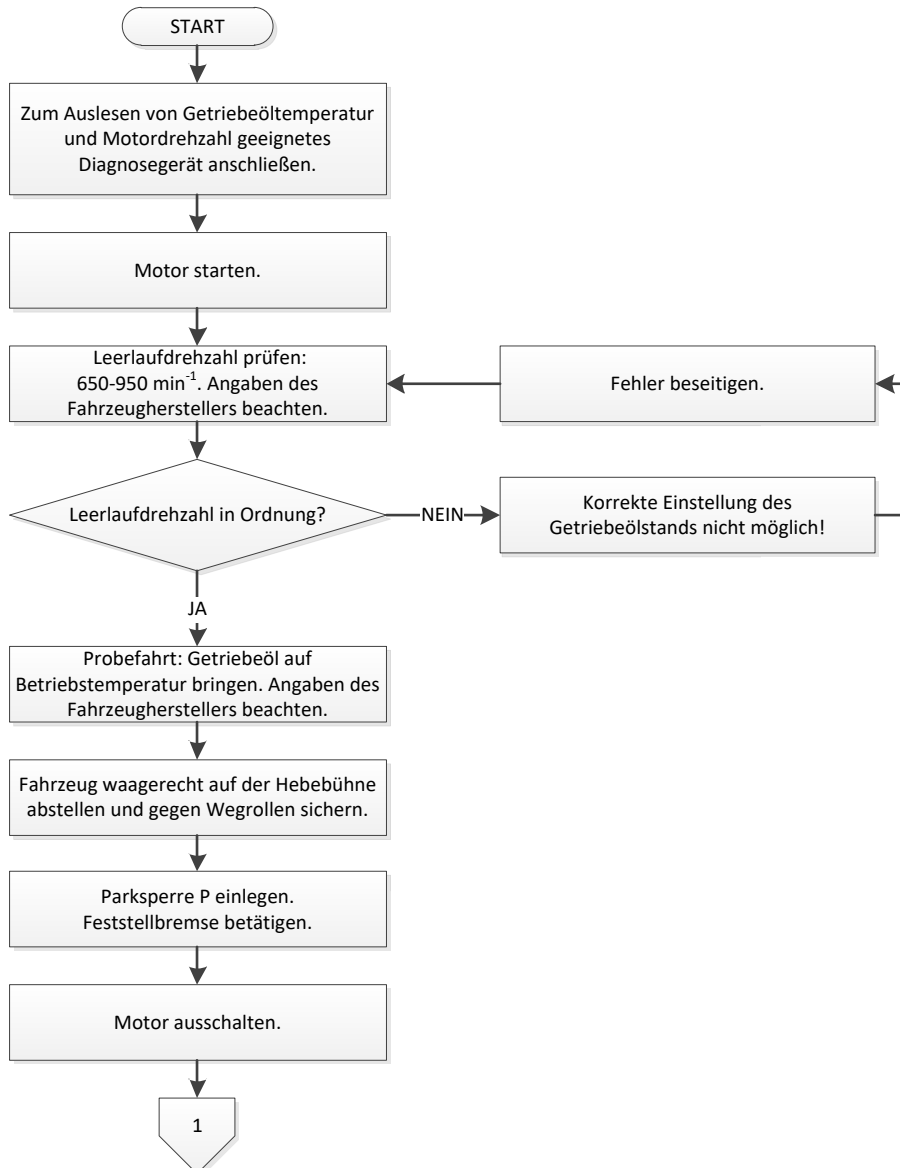



Montagehinweis Mounting instruction Instruction de montage Indicación para el montaje

DE
EN → page 15
FR → page 20
ES → page 25



VORSICHT
Verletzungsgefahr an Haut und Augen durch heiße Teile und heiße Flüssigkeiten. Verbrennungen und Verbrühungen sind möglich. Schutzbrille, Schutzhandschuhe und Schutzkleidung tragen!

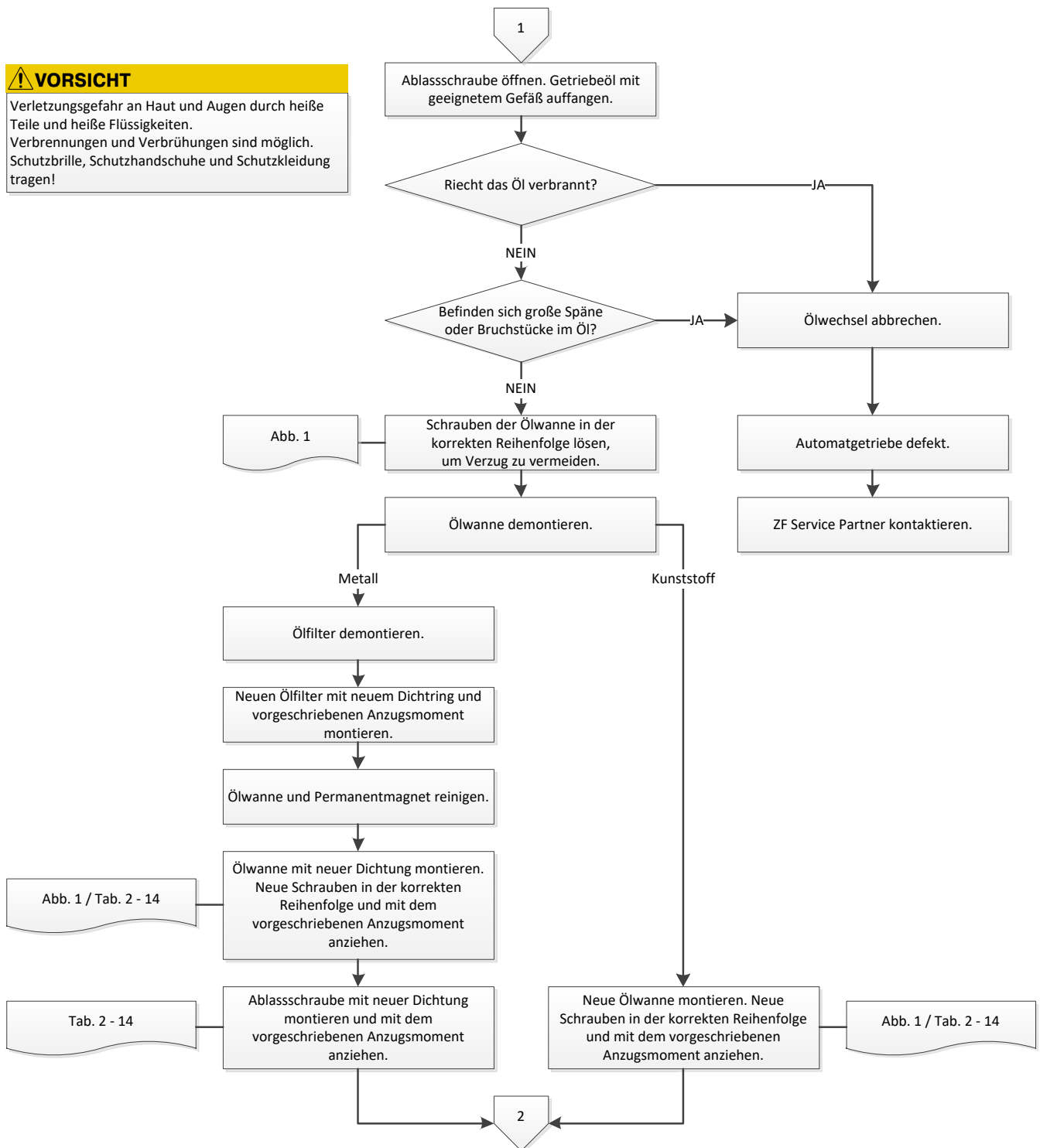



Montagehinweis
Mounting instruction
Instruction de montage
Indicación para el montaje

DE
EN → page 15
FR → page 20
ES → page 25

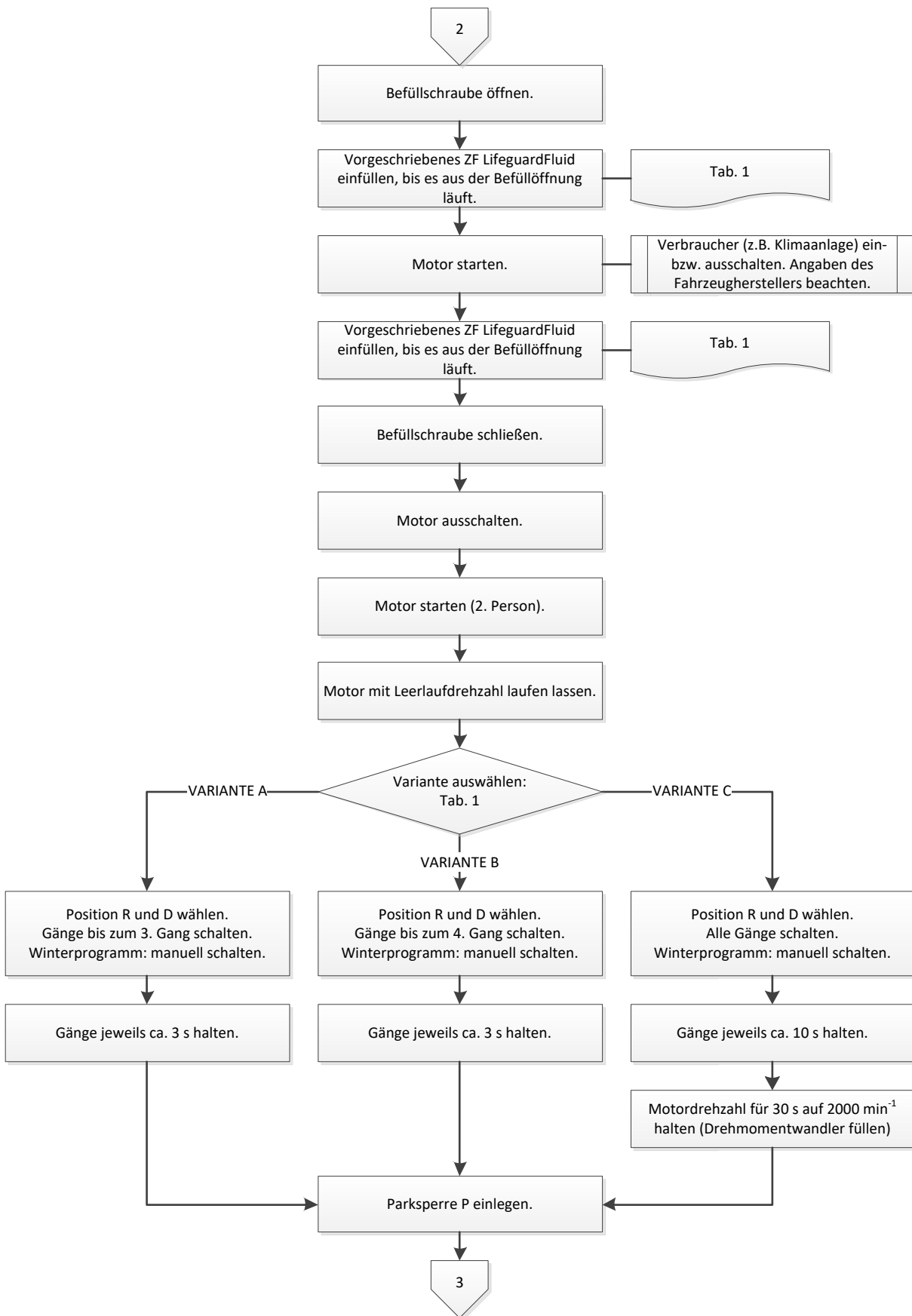



Montagehinweis
Mounting instruction
Instruction de montage
Indicación para el montaje

DE → page 15
EN → page 20
FR → page 25
ES → page 25

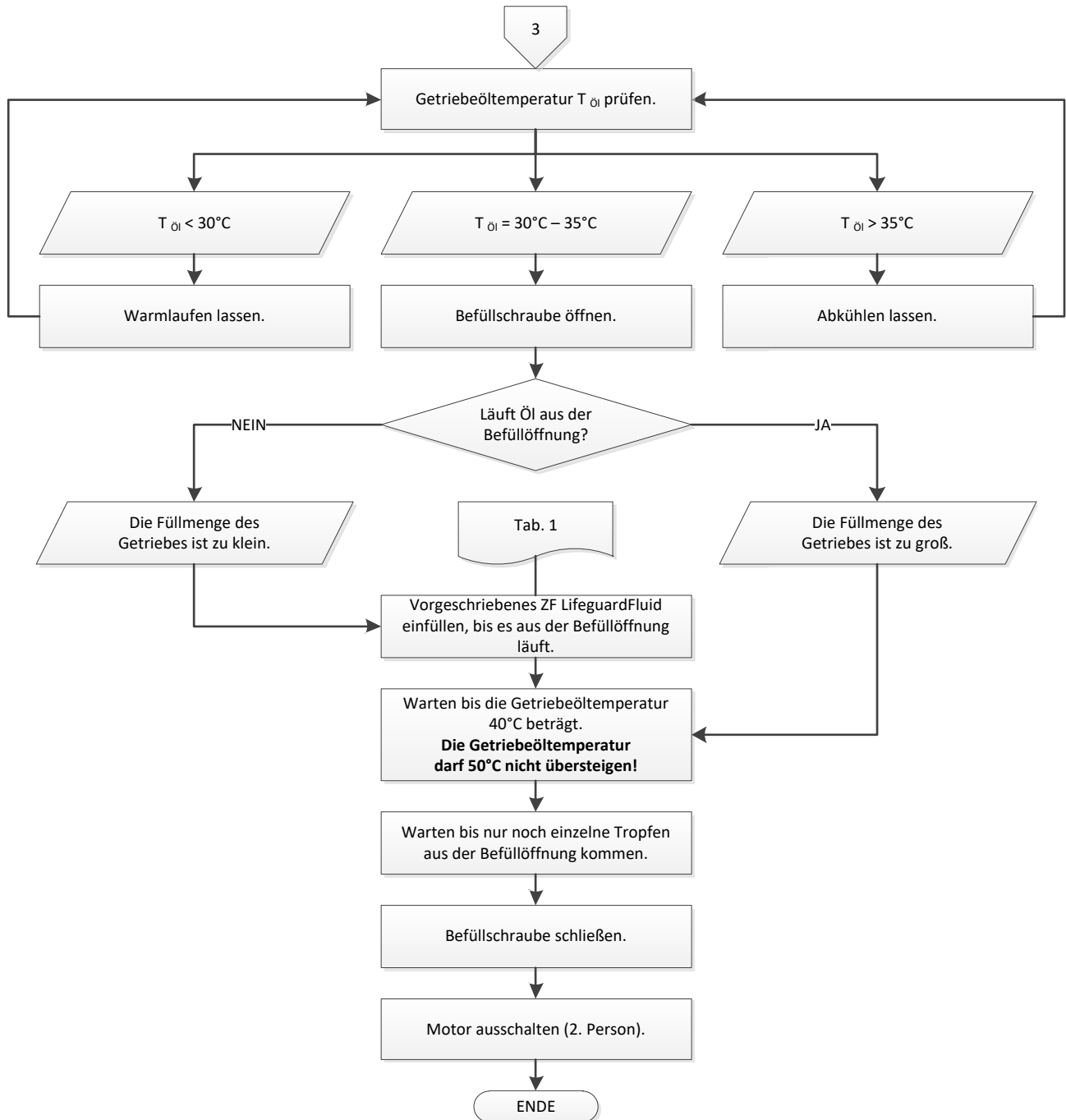



Montagehinweis
Mounting instruction
Instruction de montage
Indicación para el montaje

DE
EN → page 15
FR → page 20
ES → page 25



Abb./Fig 1: Schematische Darstellung der Anschraubreihenfolge/
 Schematic representation of the bolting sequence/
 Représentation schématique de l'ordre de vissage/
 Representación esquemática del orden de atornillado

Beispiel: Anschraubreihenfolge/
 Example: Bolting sequence/
 Exemple : ordre de vissage/
 Ejemplo: Orden de atornillado

i Schrauben der Ölwanne lösen oder anziehen: von der Mitte aus über Kreuz (Abb. 1). Zuerst alle Schrauben von Hand einschrauben, dann in der korrekten Reihenfolge mit dem korrekten Anziehdrehmoment anziehen. Angaben des Fahrzeugherstellers beachten.

i Loosen or tighten oil pan bolts: crosswise from the center outwards (Fig. 1). First screw in the bolts by hand, then tighten in the correct order with the correct torque. Follow the instructions issued by the vehicle manufacturer.

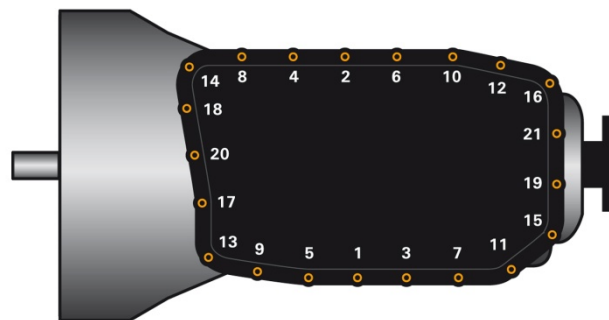
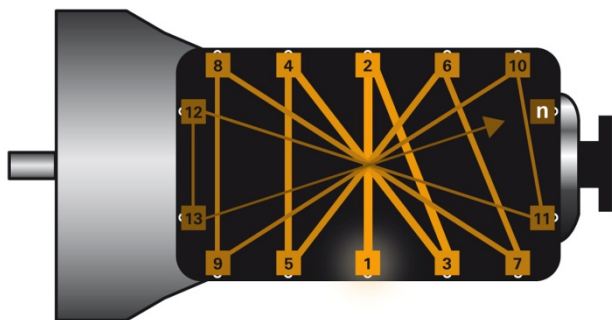
i Desserrer ou bien serrer les vis du carter d'huile : en partant du centre en croix (Fig. 1). Visser tout d'abord toutes les vis à la main, puis serrer dans le bon ordre avec le bon couple de rotation. Respecter les indications du constructeur de véhicule.

i Aflojar o apretar los tornillos del cárter de aceite: Desde el centro en diagonal (Fig. 1). Primero atornillar todos los tornillos a mano, luego fijar siguiendo el orden correcto con el par de apriete correcto. Tener en cuenta las indicaciones del fabricante del vehículo.

	Ölwanne/Oil pan/Carter d'huile/Cárter de aceite		
Material/material/Matière/Material	Aluminium/aluminum/aluminio	Kunststoff/Plastic/Matière synthétique/Material sintético	Stahlblech/Steel plate/Tôle d'acier/Chapa de acero
Anziehdrehmoment/tightening torque/couple de serrage/par de apriete	4 Nm + 45°	10 Nm	12 Nm
Ölfilter/Oil filter/Filtre à huile/Filtro de aceite	Separates Teil/ separate part/ Pièce séparée/ pieza separada	In der Ölwanne integriert/ integrated in oil pan/ intégré dans le carter d'huile/ integrado en el cárter de aceite	Separates Teil/ separate part/ Pièce séparée/ pieza separada

Tab. 2: Anziehdrehmoment/Tightening torque/Couple de serrage/Par de apriete



Montagehinweis
Mounting instruction
Instruction de montage
Indicación para el montaje

DE
EN → page 15
FR → page 20
ES → page 25



6HP19/6HP19 X/6HP21/6HP21 X (BMW)

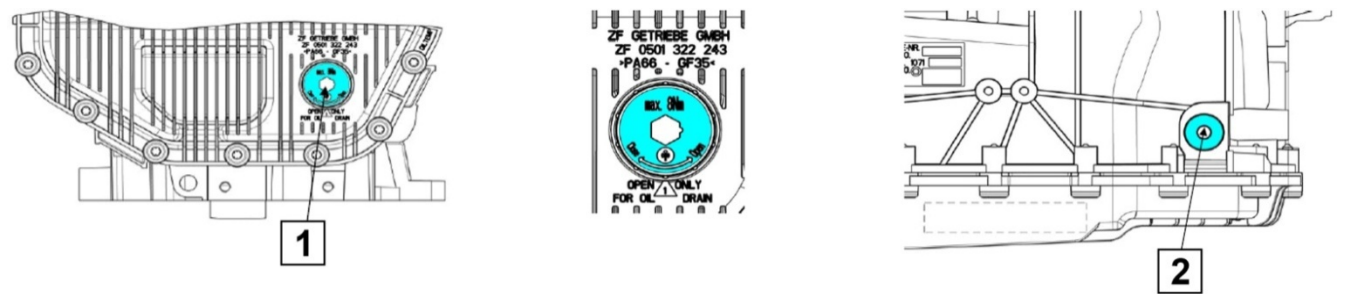

	(1)	(2)
	Ablausschraube/drain plug/ vis de vidange/tornillo de vaciado	Einfüllschraube/filler plug/ vis de remplissage/tornillo de llenado
Abmessung/dimensions/ dimensions/dimensión	M 24 x 1	M 18 x 1,5
Innensechskant/hexagon socket/ six pans creux/hexágono/interior	10 mm	8 mm
Anzugsmoment/tightening torque/ couple de serrage/par de apriete	8 Nm	35 Nm ± 3,5 Nm

Tab. 3: 6HP19/6HP19 X/6HP21/6HP21 X (BMW)

6HP19 A (Volkswagen)

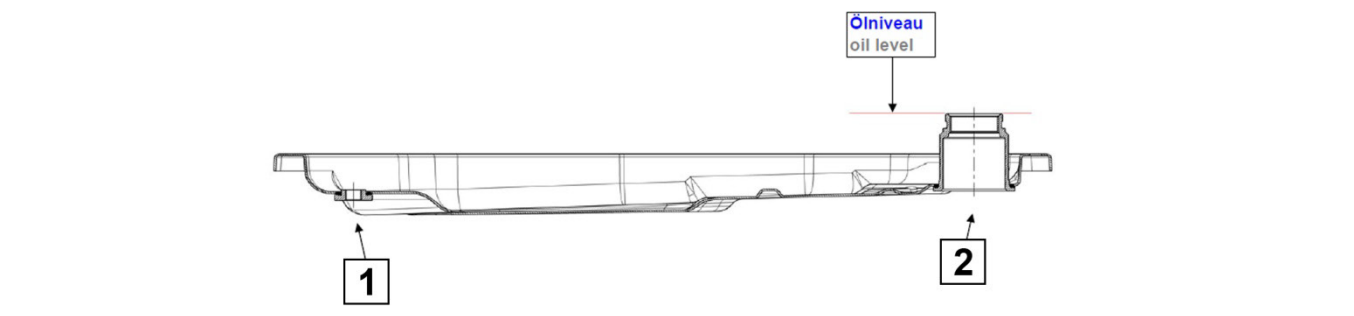

	(1)	(2)
	Ablausschraube/drain plug/ vis de vidange/tornillo de vaciado	Einfüllschraube/filler plug/ vis de remplissage/tornillo de llenado
Abmessung/dimensions/ dimensions/dimensión	M 10 x 1	M 30 x 1,5
Innensechskant/hexagon socket/ six pans creux/hexágono/interior	5 mm	17 mm
Anzugsmoment/tightening torque/ couple de serrage/par de apriete	12 Nm ± 1,2 Nm	80 Nm ± 8 Nm

Tab. 4: 6HP19 A (Volkswagen)



Montagehinweis
Mounting instruction
Instruction de montage
Indicación para el montaje

DE
EN → page 15
FR → page 20
ES → page 25



6HP26 (BMW)

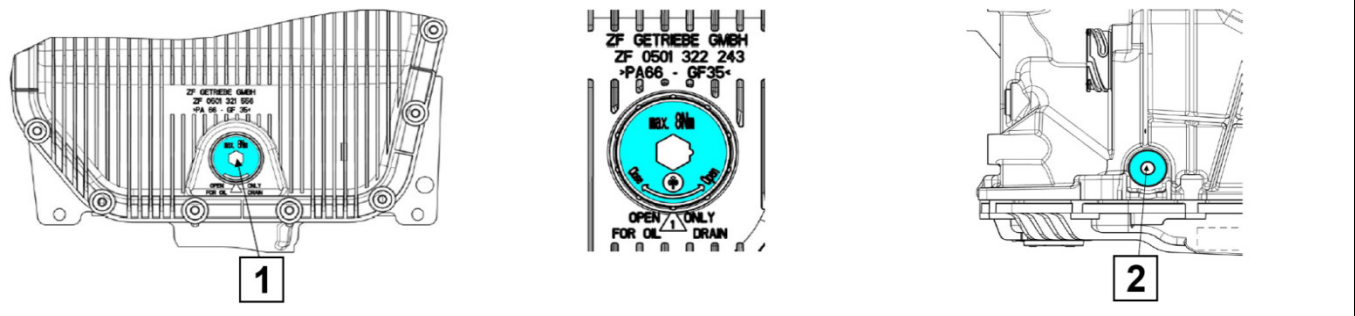

	(1)	(2)
	Ablausschraube/drain plug/ vis de vidange/tornillo de vaciado	Einfüllschraube/filler plug/ vis de remplissage/tornillo de llenado
Abmessung/dimensions/ dimensions/dimensión	M 24 x 1	M 18 x 1,5
Innensechskant/hexagon socket/ six pans creux/hexágono/interior	10 mm	8 mm
Anzugsmoment/tightening torque/ couple de serrage/par de apriete	8 Nm	35 Nm ± 3,5 Nm

Tab. 5: 6HP26 (BMW)

6HP26 (Jaguar)

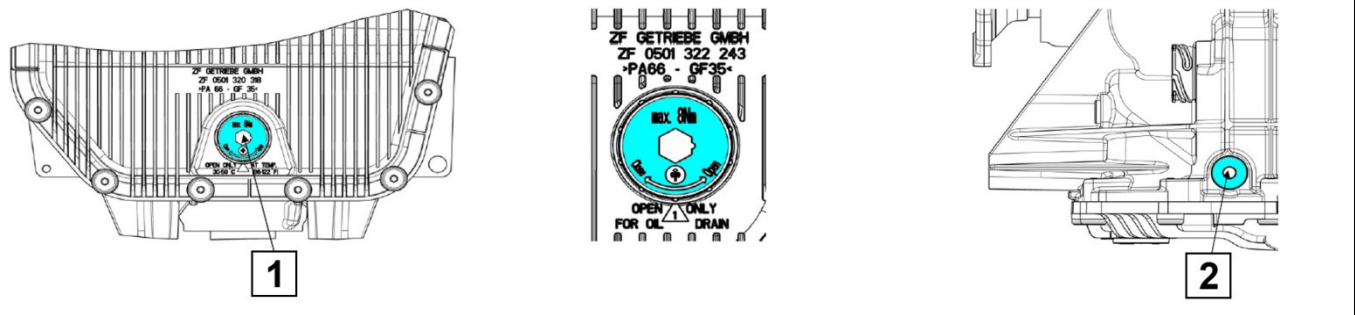

	(1)	(2)
	Ablausschraube/drain plug/ vis de vidange/tornillo de vaciado	Einfüllschraube/filler plug/ vis de remplissage/tornillo de llenado
Abmessung/dimensions/ dimensions/dimensión	M 24 x 1	M 18 x 1,5
Innensechskant/hexagon socket/ six pans creux/hexágono/interior	10 mm	8 mm
Anzugsmoment/tightening torque/ couple de serrage/par de apriete	8 Nm	35 Nm ± 3,5 Nm

Tab. 6: 6HP26 (Jaguar)



Montagehinweis
Mounting instruction
Instruction de montage
Indicación para el montaje

DE
EN → page 15
FR → page 20
ES → page 25



6HP26 X (BMW)

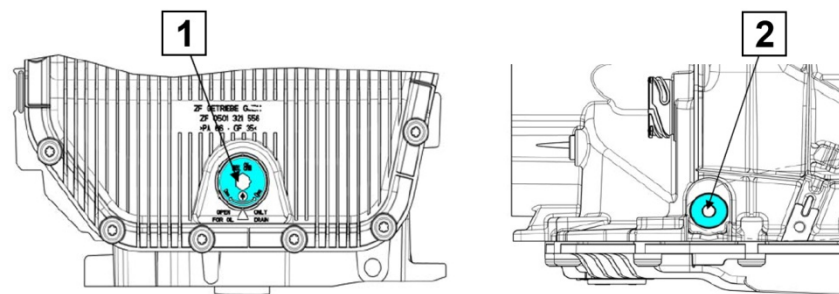

	(1)	(2)
	Ablassschraube/drain plug/ vis de vidange/tornillo de vaciado	Einfüllschraube/filler plug/ vis de remplissage/tornillo de llenado
Abmessung/dimensions/ dimensions/dimensión	M 24 x 1	M 18 x 1,5
Innensechskant/hexagon socket/ six pans creux/hexágono/interior	10 mm	8 mm
Anzugsmoment/tightening torque/ couple de serrage/par de apriete	8 Nm	35 Nm ± 3,5 Nm

Tab. 7: 6HP26 X (BMW)

6HP26 X (Land Rover)

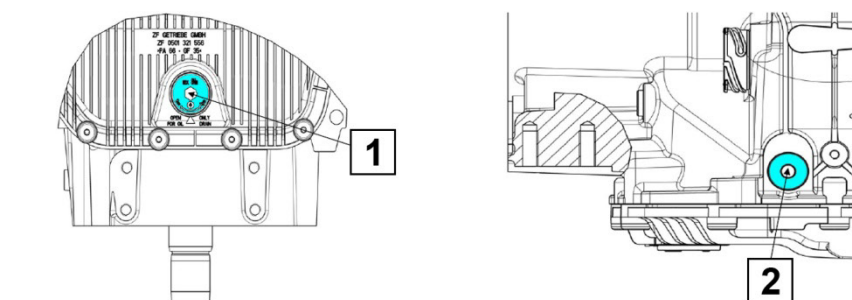

	(1)	(2)
	Ablassschraube/drain plug/ vis de vidange/tornillo de vaciado	Einfüllschraube/filler plug/ vis de remplissage/tornillo de llenado
Abmessung/dimensions/ dimensions/dimensión	M 24 x 1	M 18 x 1,5
Innensechskant/hexagon socket/ six pans creux/hexágono/interior	10 mm	8 mm
Anzugsmoment/tightening torque/ couple de serrage/par de apriete	8 Nm	35 Nm ± 3,5 Nm

Tab. 8: 6HP26 X (Land Rover)



Montagehinweis
Mounting instruction
Instruction de montage
Indicación para el montaje

DE
EN → page 15
FR → page 20
ES → page 25



6HP28 (BMW)

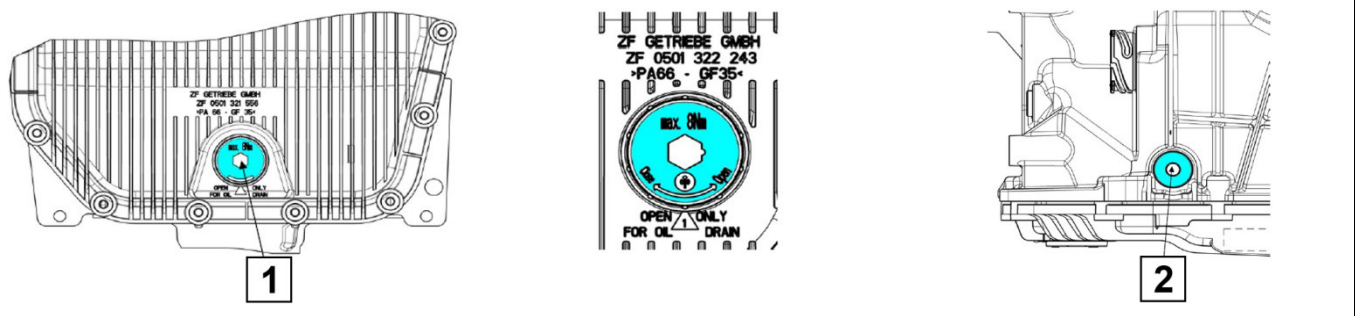

	(1)	(2)
	Ablassschraube/drain plug/ vis de vidange/tornillo de vaciado	Einfüllschraube/filler plug/ vis de remplissage/tornillo de llenado
Abmessung/dimensions/ dimensions/dimensión	M 24 x 1	M 18 x 1,5
Innensechskant/hexagon socket/ six pans creux/hexágono/interior	10 mm	8 mm
Anzugsmoment/tightening torque/ couple de serrage/par de apriete	8 Nm	35 Nm ± 3,5 Nm

Tab. 9: 6HP28 (BMW)

6HP28 X (BMW)

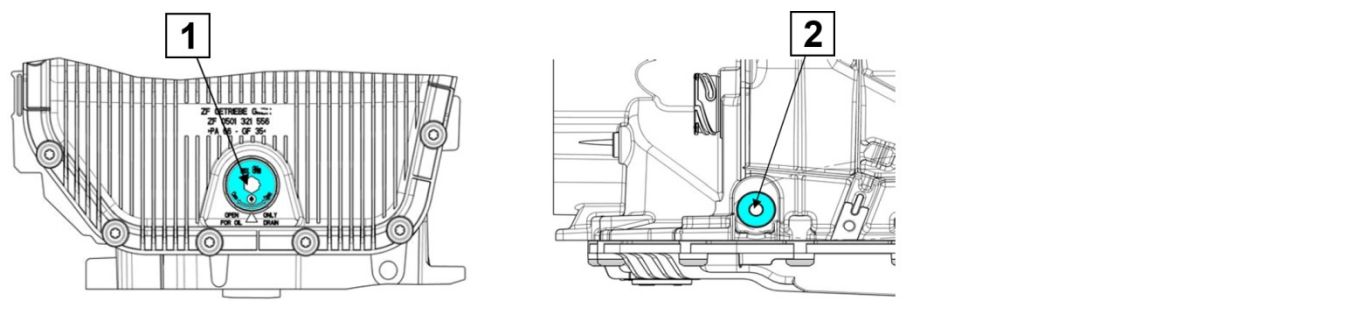

	(1)	(2)
	Ablassschraube/drain plug/ vis de vidange/tornillo de vaciado	Einfüllschraube/filler plug/ vis de remplissage/tornillo de llenado
Abmessung/dimensions/ dimensions/dimensión	M 24 x 1	M 18 x 1,5
Innensechskant/hexagon socket/ six pans creux/hexágono/interior	10 mm	8 mm
Anzugsmoment/tightening torque/ couple de serrage/par de apriete	8 Nm	35 Nm ± 3,5 Nm

Tab. 10: 6HP28 X (BMW)



Montagehinweis
Mounting instruction
Instruction de montage
Indicación para el montaje

DE
EN → page 15
FR → page 20
ES → page 25



6HP32 (BMW)

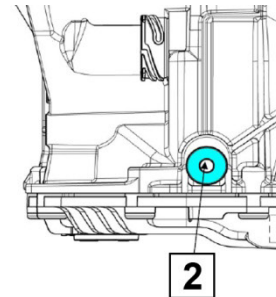
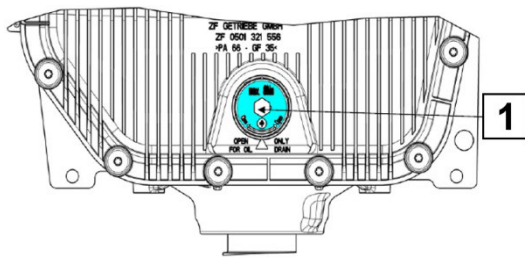

	(1)	(2)
	Ablassschraube/drain plug/ vis de vidange/tornillo de vaciado	Einfüllschraube/filler plug/ vis de remplissage/tornillo de llenado
Abmessung/dimensions/ dimensions/dimensión	M 24 x 1	M 18 x 1,5
Innensechskant/hexagon socket/ six pans creux/hexágono/interior	10 mm	8 mm
Anzugsmoment/tightening torque/ couple de serrage/par de apriete	8 Nm	35 Nm ± 3,5 Nm

Tab. 11: 6HP32 (BMW)

6HP26 X (BMW)

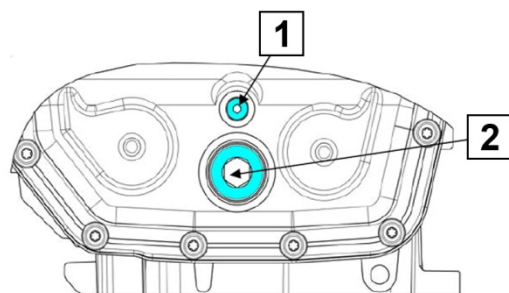

	(1)	(2)
	Ablassschraube/drain plug/ vis de vidange/tornillo de vaciado	Einfüllschraube/filler plug/ vis de remplissage/tornillo de llenado
Abmessung/dimensions/ dimensions/dimensión	M 10 x 1	M 30 x 1,5
Innensechskant/hexagon socket/ six pans creux/hexágono/interior	5 mm	17 mm
Anzugsmoment/tightening torque/ couple de serrage/par de apriete	12 Nm ± 1,2 Nm	80 Nm ± 8 Nm

Tab. 12: 6HP26 X (BMW)



Montagehinweis
Mounting instruction
Instruction de montage
Indicación para el montaje

DE
EN → page 15
FR → page 20
ES → page 25



6HP26 A61 (Audi/Bentley)

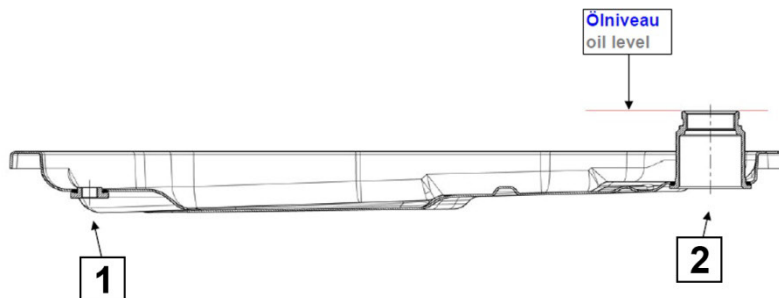

	(1)	(2)
	Ablassschraube/drain plug/ vis de vidange/tornillo de vaciado	Einfüllschraube/filler plug/ vis de remplissage/tornillo de llenado
Abmessung/dimensions/ dimensions/dimensión	M 10 x 1	M 30 x 1,5
Innensechskant/hexagon socket/ six pans creux/hexágono/interior	5 mm	17 mm
Anzugsmoment/tightening torque/ couple de serrage/par de apriete	12 Nm ± 1,2 Nm	80 Nm ± 8 Nm

Tab. 13: 6HP26 A61 (Audi/Bentley)

6HP28 AF (Audi)

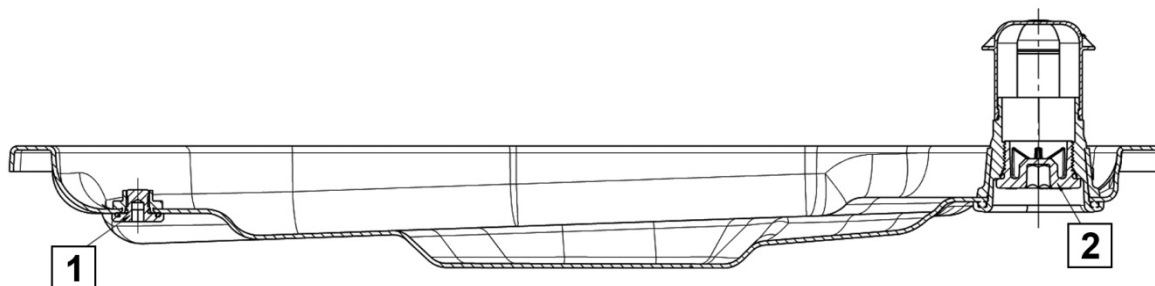

	(1)	(2)
	Ablassschraube/drain plug/ vis de vidange/tornillo de vaciado	Einfüllschraube/filler plug/ vis de remplissage/tornillo de llenado
Abmessung/dimensions/ dimensions/dimensión	M 30 x 1,5	M 18 x 1,5
Innensechskant/hexagon socket/ six pans creux/hexágono/interior	10 mm	5 mm
Anzugsmoment/tightening torque/ couple de serrage/par de apriete	8 Nm	12 Nm ± 1,2 Nm

Tab. 14: 6HP28 AF (Audi)



Montagehinweis
Mounting instruction
Instruction de montage
Indicación para el montaje

DE
EN → page 15
FR → page 20
ES → page 25



Oil change kit for ZF 5HP/6HP automatic transmission

CAUTION

Risk of burns due to contact with hot oil.
Slight to moderate injury possible.

- ⇒ Wear protective goggles.
- ⇒ Wear protective gloves.
- ⇒ Wear protective clothing.

NOTICE

Property damage due to electrostatic discharge (ESD) possible.

- ⇒ Observe ESD protection.
- ⇒ Do not touch the contacts.
- ⇒ Wear conductive workwear.
- ⇒ Use ESD transport.
- ⇒ Use ESD protective packaging.



NOTICE

Observe the following instructions to prevent damage to the transmission:

- Do **not** tow vehicle if transmission is without oil. Observe the vehicle manufacturer specifications.
- For cleaning only use clean, **lint-free** cloths.
- Do **not** start the engine if there is no oil in the transmission.
- Only use the specified **ZF-LifeguardFluid** (Tab. 1).
- Do not use any further additives as they alter the chemical composition of the oil!
- Adjust the oil level in the transmission exactly according to filling regulations. If the oil level is too low, the transmission will be damaged. If the oil level is too high, the excess oil will leak from the transmission through the overflow when heated. The escaping oil can ignite on hot parts (e.g. exhaust system).
- Adhere to the bolting sequence (Fig. 1).
- Observe tightening torques (Tab. 2 - 14).

 Before changing the oil: Read instructions carefully. Check which version (A/B/C) applies to the oil change (Table 1).

 ZF automatic transmissions are filled with specially developed semi-synthetic oils. At very high operating temperatures, the oil ages faster than under normal conditions.

Examples:

- Many trips at high speeds.
- Many trips with a trailer in tow.
- Sporty driving.

 Observe the service information:

- 50324 EN (Guide Sleeve Mechatronics for ZF Automatic Transmission 6HP)
- 50638 EN (Seal Kits for ZF 6HP Automatic Transmissions)



Montagehinweis
Mounting instruction
Instruction de montage
Indicación para el montaje

DE
EN → page 15
FR → page 20
ES → page 25

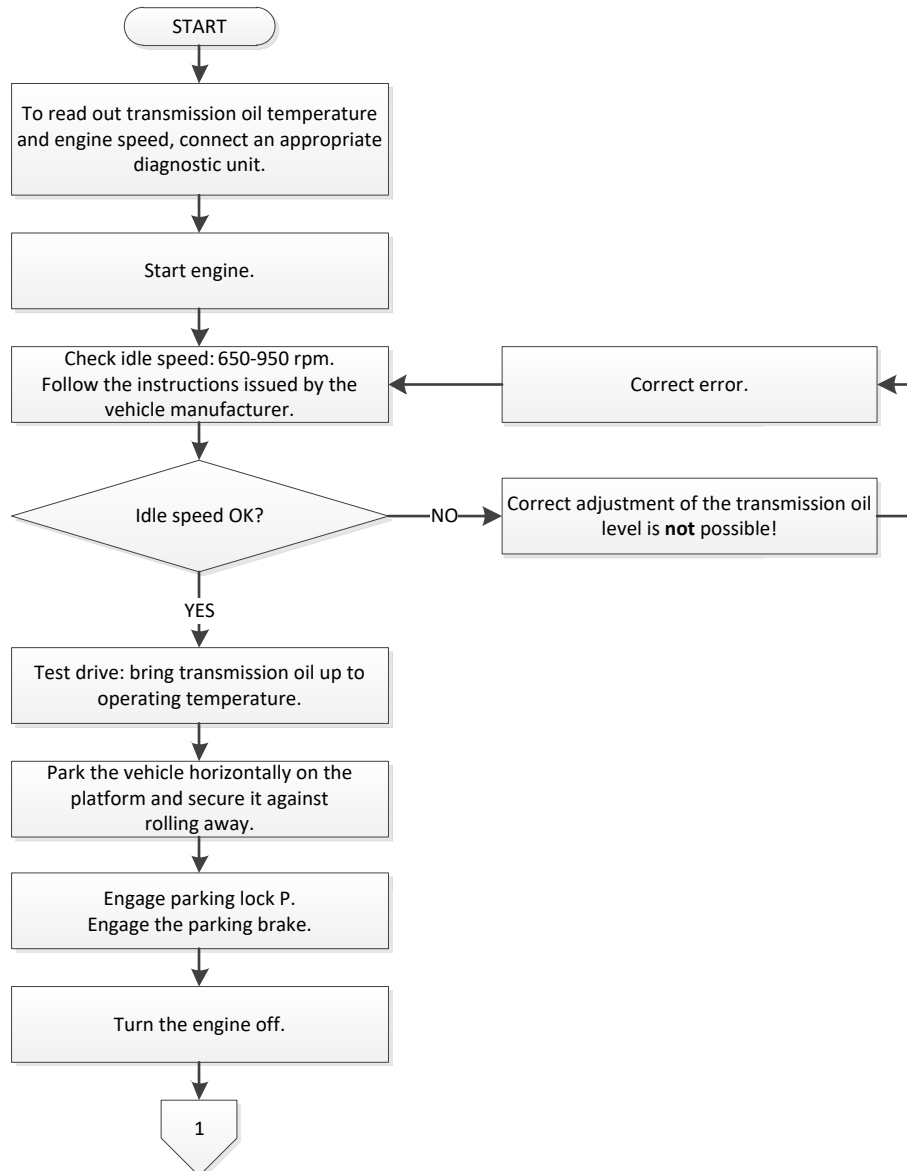



Montagehinweis Mounting instruction Instruction de montage Indicación para el montaje

DE → page 15
EN → page 20
FR → page 25
ES → page 25



CAUTION
Risk of injury to skin and eyes from hot components and hot liquids.
Burns and scalds are possible.
Always wear safety goggles, protective gloves, and protective clothing!

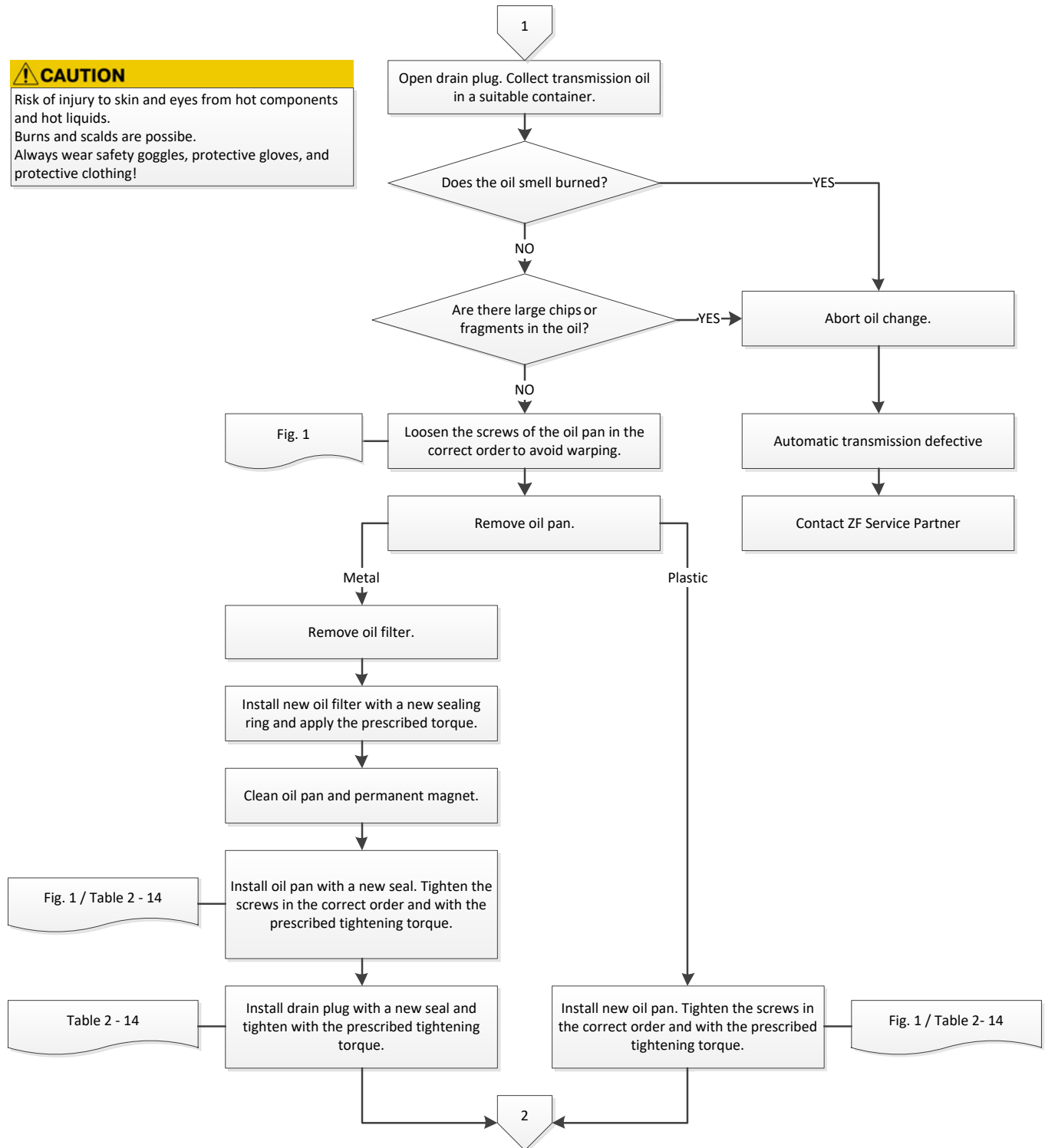



Montagehinweis
Mounting instruction
Instruction de montage
Indicación para el montaje

DE
EN → page 15
FR → page 20
ES → page 25

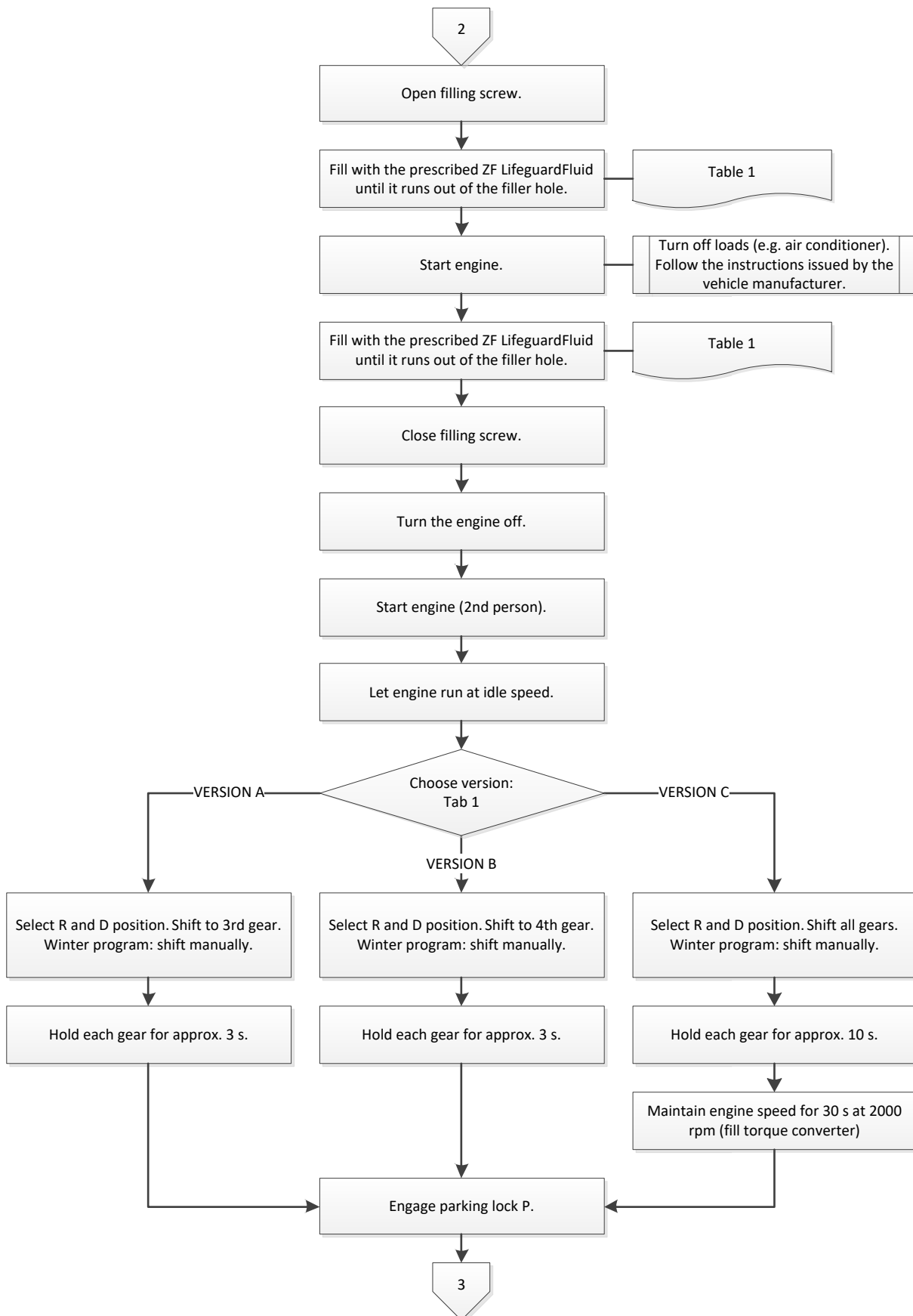



Montagehinweis
Mounting instruction
Instruction de montage
Indicación para el montaje

DE
EN → page 15
FR → page 20
ES → page 25

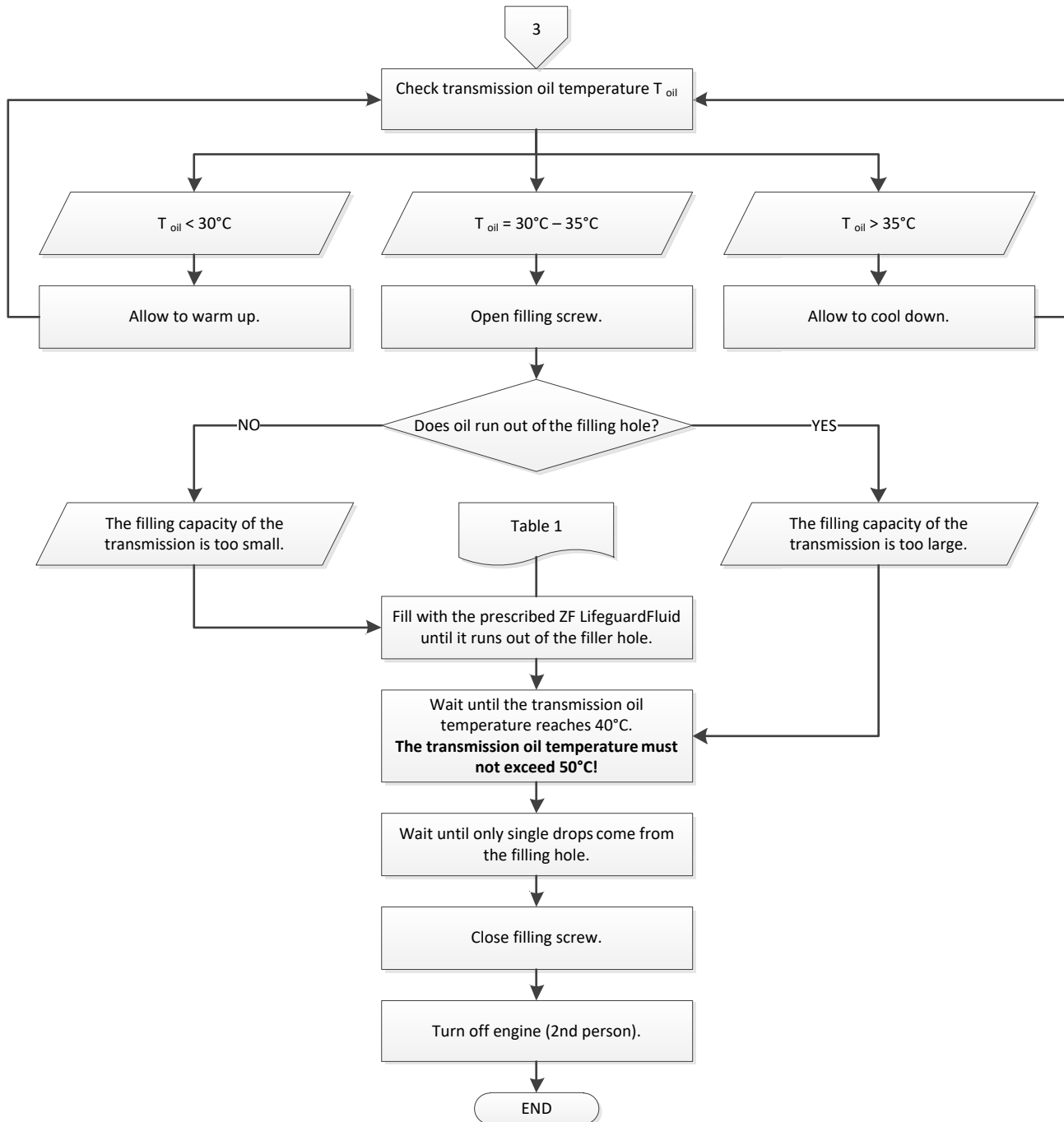



Montagehinweis
Mounting instruction
Instruction de montage
Indicación para el montaje

DE
EN → page 15
FR → page 20
ES → page 25



Kit de vidange d'huile pour boîte de vitesses automatique ZF 5HP/6HP

! ATTENTION

Risque de brûlure par contact avec de l'huile chaude
Des blessures légères à modérées sont possibles

- ⇒ Porter des lunettes de protection.
- ⇒ Porter des gants de protection.
- ⇒ Porter des vêtements de protection.

AVIS

Possibilité de dommages matériels dus à une décharge électrostatique (ESD).

- ⇒ Respecter la protection ESD.
- ⇒ Ne pas toucher les contacts.
- ⇒ Porter des vêtements de travail antistatiques.
- ⇒ Utiliser une protection de transport ESD.
- ⇒ Utiliser un emballage de protection ESD.



AVIS

Respecter les indications suivantes afin d'éviter un dommage au niveau de la boîte de vitesses :

- **Ne pas** remorquer de véhicule sans huile de boîte de vitesses. Respecter les indications du constructeur de véhicule.
- Pour le nettoyage, utiliser uniquement des chiffons **non pelucheux**.
- **Ne pas** laisser tourner le moteur quand il n'y a pas d'huile dans la boîte de vitesses.
- Utiliser exclusivement le **ZF LifeguardFluid** prescrit pour chaque boîte de vitesses ! (Tab. 1)
- Ne pas utiliser d'additifs supplémentaires car ils modifient la composition chimique de l'huile !
- Régler le niveau d'huile de la boîte de vitesses exactement conformément aux consignes de remplissage. En cas de niveau d'huile trop faible, la boîte de vitesses est endommagée. Si le niveau d'huile est trop élevé, en cas d'échauffement, l'huile excédentaire déborde de la boîte de vitesses. L'huile s'échappant peut s'enflammer au contact de pièces chaudes (p. ex. système d'échappement).
- Respecter l'ordre de vissage (Fig. 1)
- Respecter les couples de serrage (Tab. 2 - 14).

 Avant la vidange d'huile : lire attentivement la notice. Contrôler quelle variante (A/B/C) s'applique pour la vidange d'huile (Tab. 1).

 Les boîtes de vitesses automatiques sont remplies d'huiles semi-synthétiques spécialement conçues. En cas de températures de fonctionnement très élevées, l'huile vieillit plus vite que dans des conditions normales.

Exemples :

- De nombreux trajets à grandes vitesses.
- De nombreux trajets avec remorque.
- Conduite sportive.

 Respecter l'information de service :

- 50324 FR (Douille de guidage mécatronique pour boîte de vitesses automatique ZF 6HP)
- 50638 FR (Jeux de joints d'étanchéité pour boîte de vitesses automatique ZF 6HP)



Montagehinweis
Mounting instruction
Instruction de montage
Indicación para el montaje

DE → page 15
EN → page 20
FR → page 25
ES → page 25

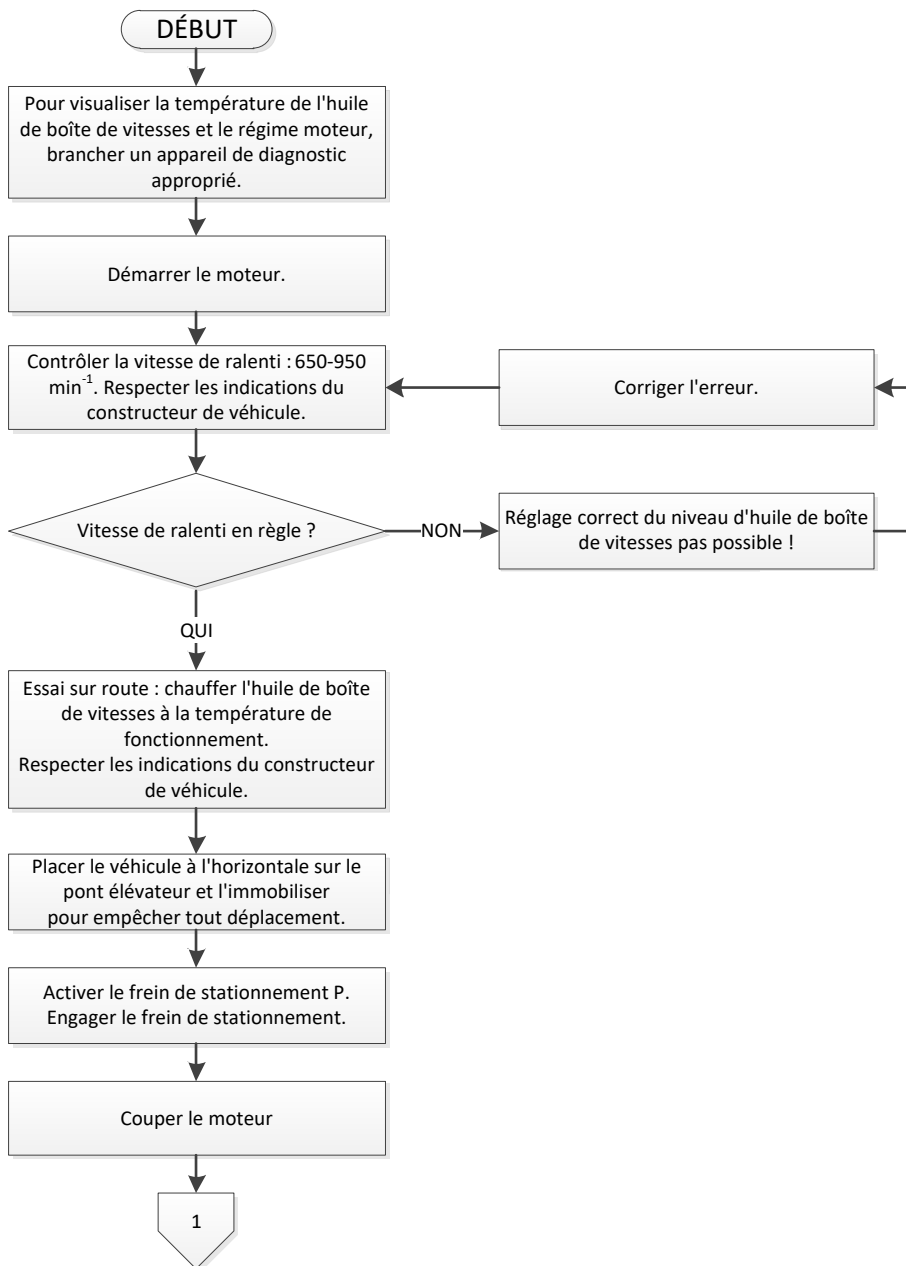



Montagehinweis

Mounting instruction

Instruction de montage

Indicación para el montaje

DE → page 15
EN → page 20
FR → page 25
ES → page 25



⚠ ATTENTION

Risque de blessure au niveau de la peau et des yeux causée par des pièces ou des liquides chauds. Des brûlures et ébouillantage sont possibles. Porter des lunettes de protection, des gants de protection ainsi que des vêtements de protection !

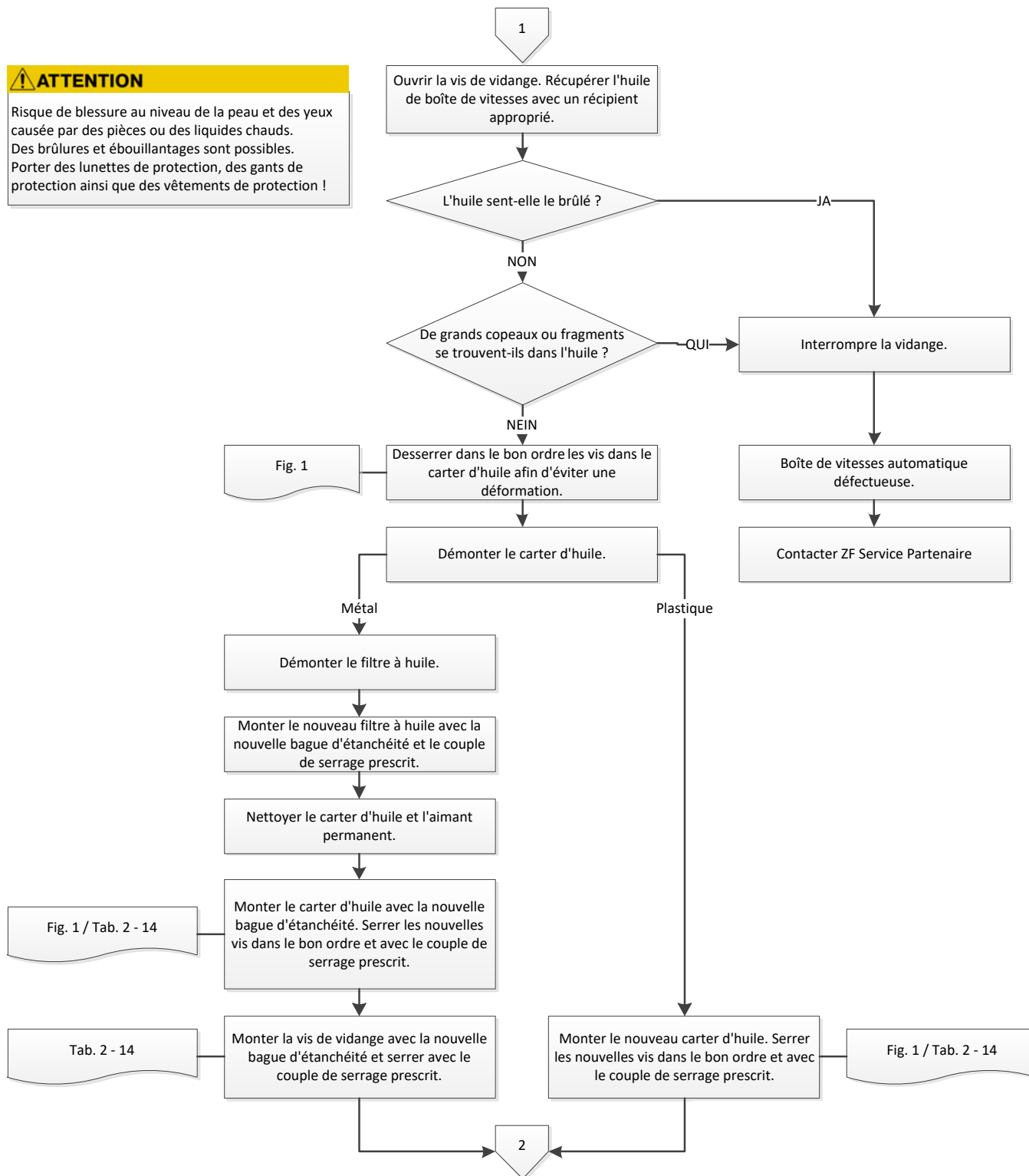



Montagehinweis
Mounting instruction
Instruction de montage
Indicación para el montaje

DE
EN → page 15
FR → page 20
ES → page 25

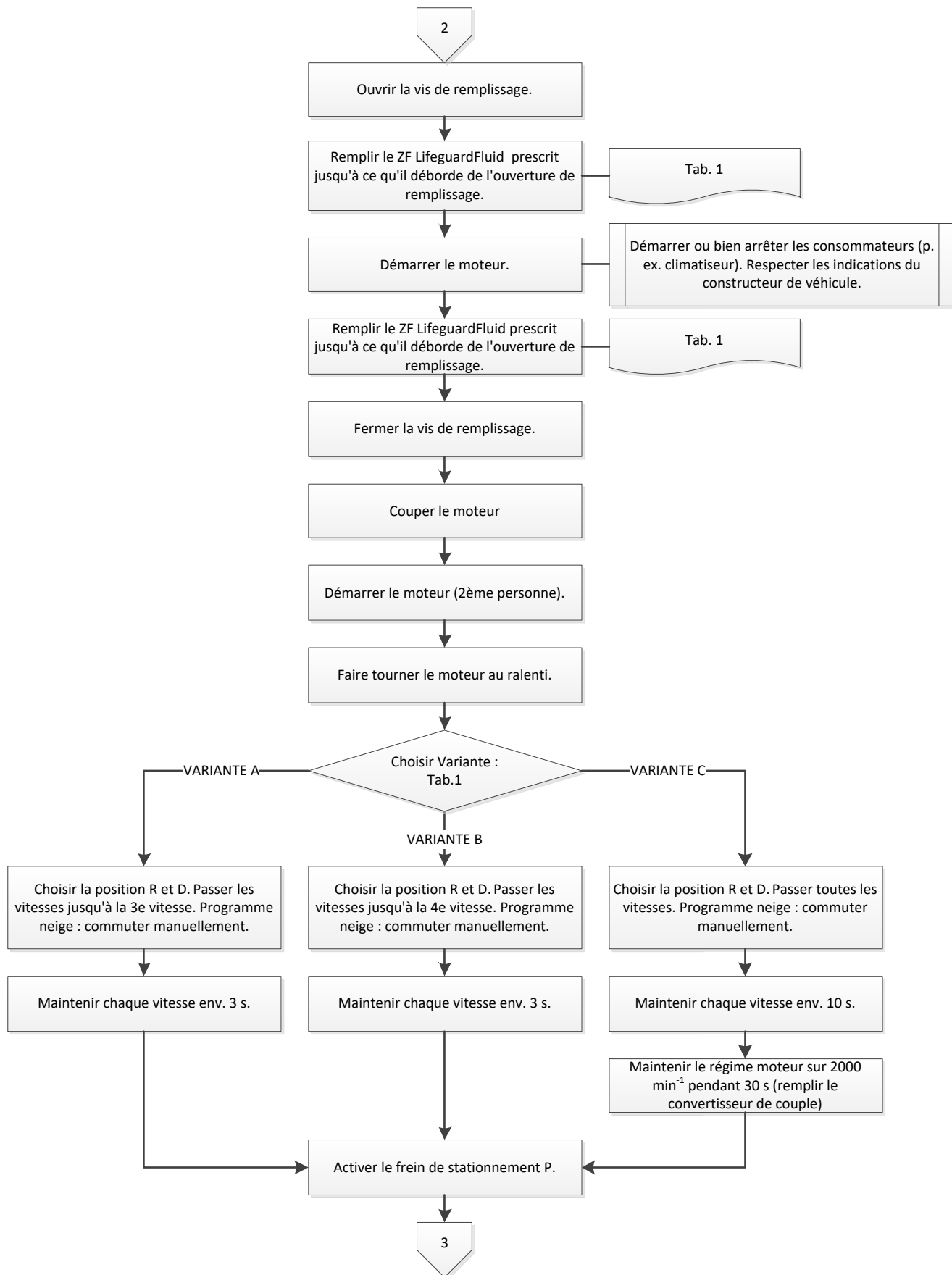



Montagehinweis
Mounting instruction
Instruction de montage
Indicación para el montaje

DE → page 15
EN → page 20
FR → page 25
ES → page 25

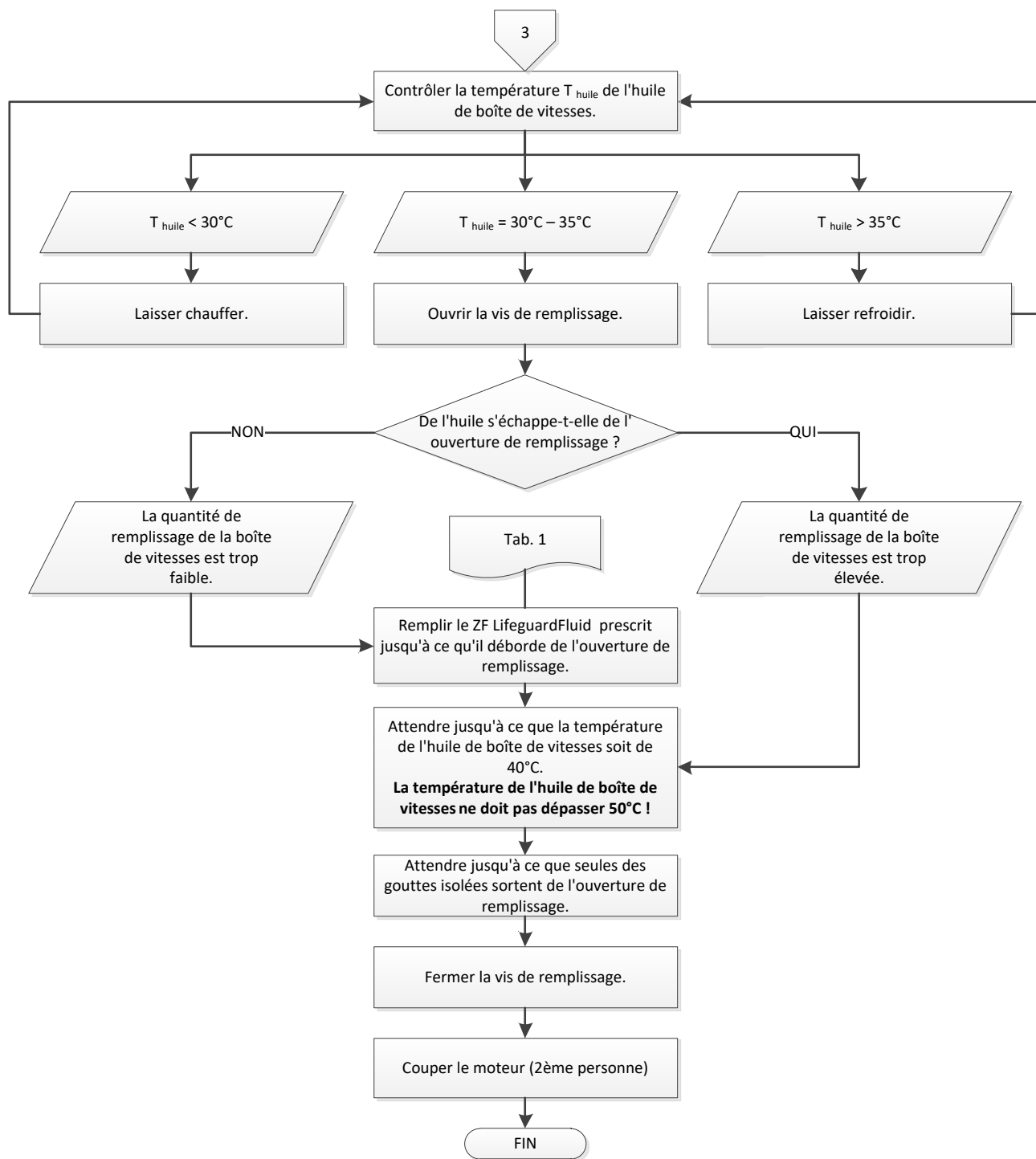



Montagehinweis
Mounting instruction
Instruction de montage
Indicación para el montaje

DE
EN → page 15
FR → page 20
ES → page 25



Kit de cambio de aceite para caja de cambios automática ZF 5HP/6HP

! ATENCIÓN

Peligro de sufrir quemaduras por el contacto con el aceite caliente.
Podrían producirse lesiones de leves a intermedias.

- ⇒ Lleve gafas de protección.
- ⇒ Lleve guantes de protección.
- ⇒ Lleve ropa de protección.

AVISO

Posibilidad de daños materiales por descarga electrostática (ESD)

- ⇒ Tenga en cuenta la protección contra ESD.
- ⇒ No toque los contactos.
- ⇒ Lleve ropa de trabajo que desvíe las cargas eléctricas.
- ⇒ Utilice la protección de transporte contra ESD.
- ⇒ Utilice el embalaje de protección contra ESD.



AVISO

Observar las indicaciones siguientes para evitar daños en la caja de cambios:

- **No** remolcar el vehículo sin que la caja de cambios esté llena de aceite. Tener en cuenta las indicaciones del fabricante del vehículo.
- Utilizar únicamente paños limpios y **sin pelusa** para limpiar.
- **No** hacer funcionar el motor si no hay aceite en la caja de cambios.
- ¡Utilizar exclusivamente el **ZF LifeguardFluid** prescrito para la caja de cambios respectiva! (Tab. 1)
- ¡No utilizar aditivos adicionales porque éstos cambian la composición química del aceite!
- Ajustar el nivel de aceite para la caja de cambios exactamente según las normas de llenado. Un nivel de aceite demasiado bajo daña la caja de cambios. Con un nivel de aceite demasiado alto se sale el aceite sobrante al calentarse por el rebosadero de la caja de cambios. El aceite que se sale puede encenderse en componentes calientes (p. ej. el tubo de escape).
- Observar el orden de atornillado (Fig. 1)
- Observar los pares de apriete (Tab. 2 - 14).



Leer detenidamente las instrucciones antes de proceder al cambio de aceite. Comprobar cuáles son las variantes (A/B/C) que son válidas para el cambio de aceite (Tab. 1).



Las cajas de cambios automáticas de ZF van llenas de aceites semisintéticos concebidos especialmente para este fin. El aceite envejece más rápidamente a temperaturas de servicio muy elevadas que bajo condiciones normales.

Ejemplos:

- Conducción frecuente a alta velocidad.
- Conducción frecuente con remolque.
- Un modo deportivo de conducir.



Prestar atención a la información de servicio:

- 50324 ES (Casquillo de guía de mecatrónica para la caja de cambios automática ZF 6HP)
- 50638 ES (Juegos de juntas para cajas de cambio automáticas 6HP de ZF)



Montagehinweis
Mounting instruction
Instruction de montage
Indicación para el montaje

DE → page 15
EN → page 20
FR → page 20
ES → page 25

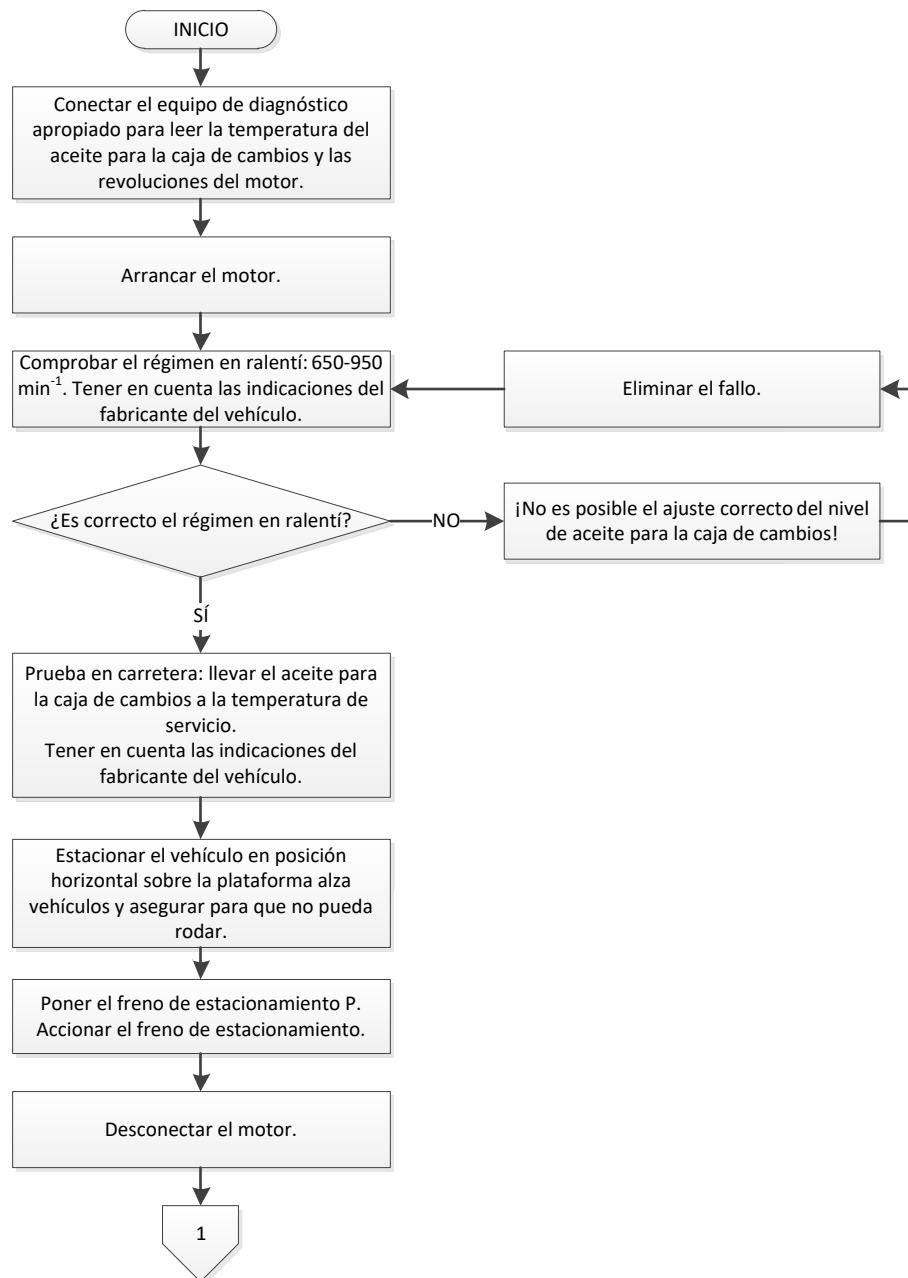



Montagehinweis

Mounting instruction

Instruction de montage

Indicación para el montaje

DE → page 15
EN → page 20
FR → page 25
ES → page 25



⚠ ATENCIÓN
Peligro de lesión en piel y ojos debido a piezas calientes y líquidos calientes.
Es posible quemarse y escaldarse.
¡Usar gafas, guantes y ropa de protección!

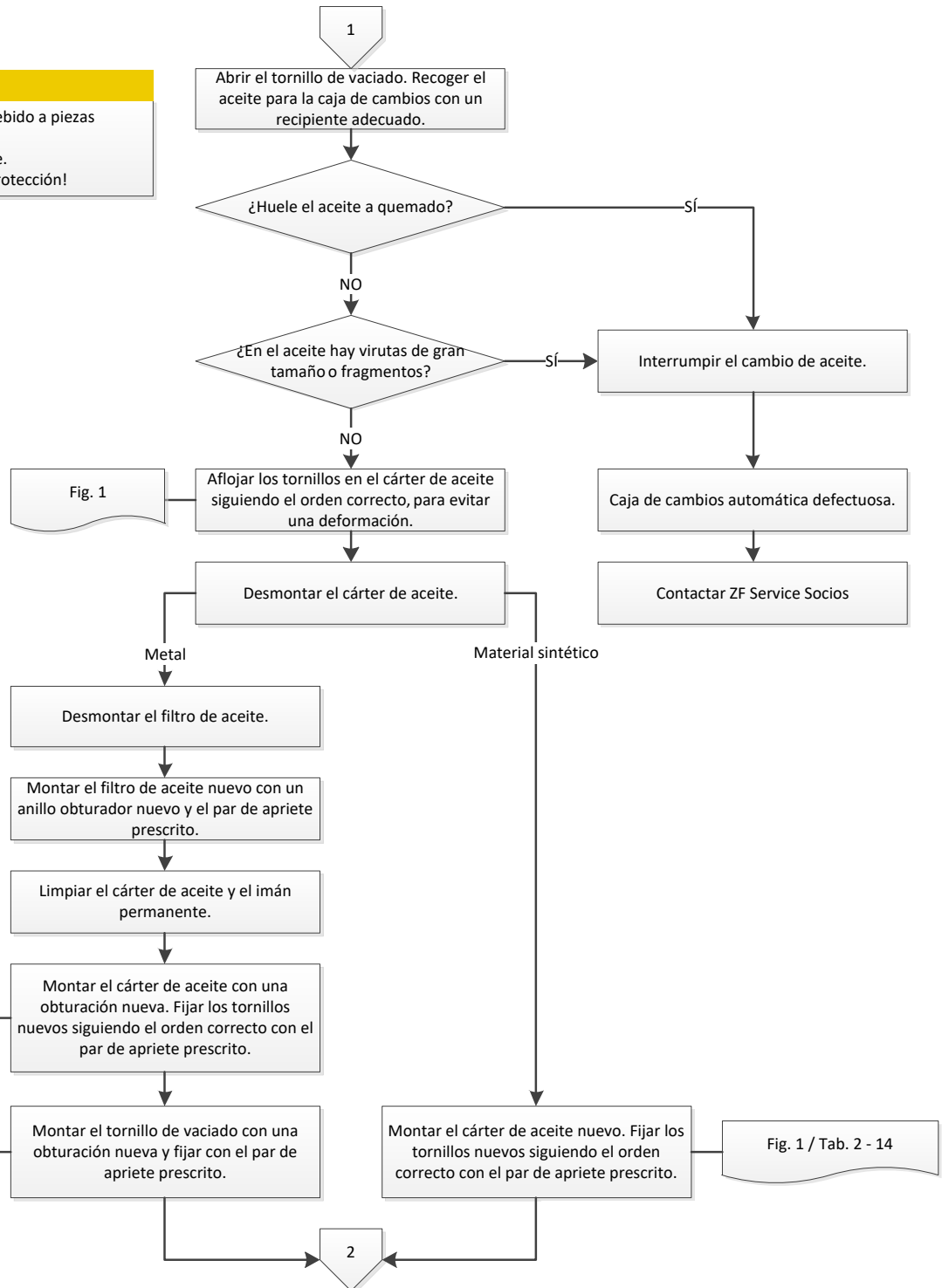



Montagehinweis
Mounting instruction
Instruction de montage
Indicación para el montaje

DE
EN → page 15
FR → page 20
ES → page 25

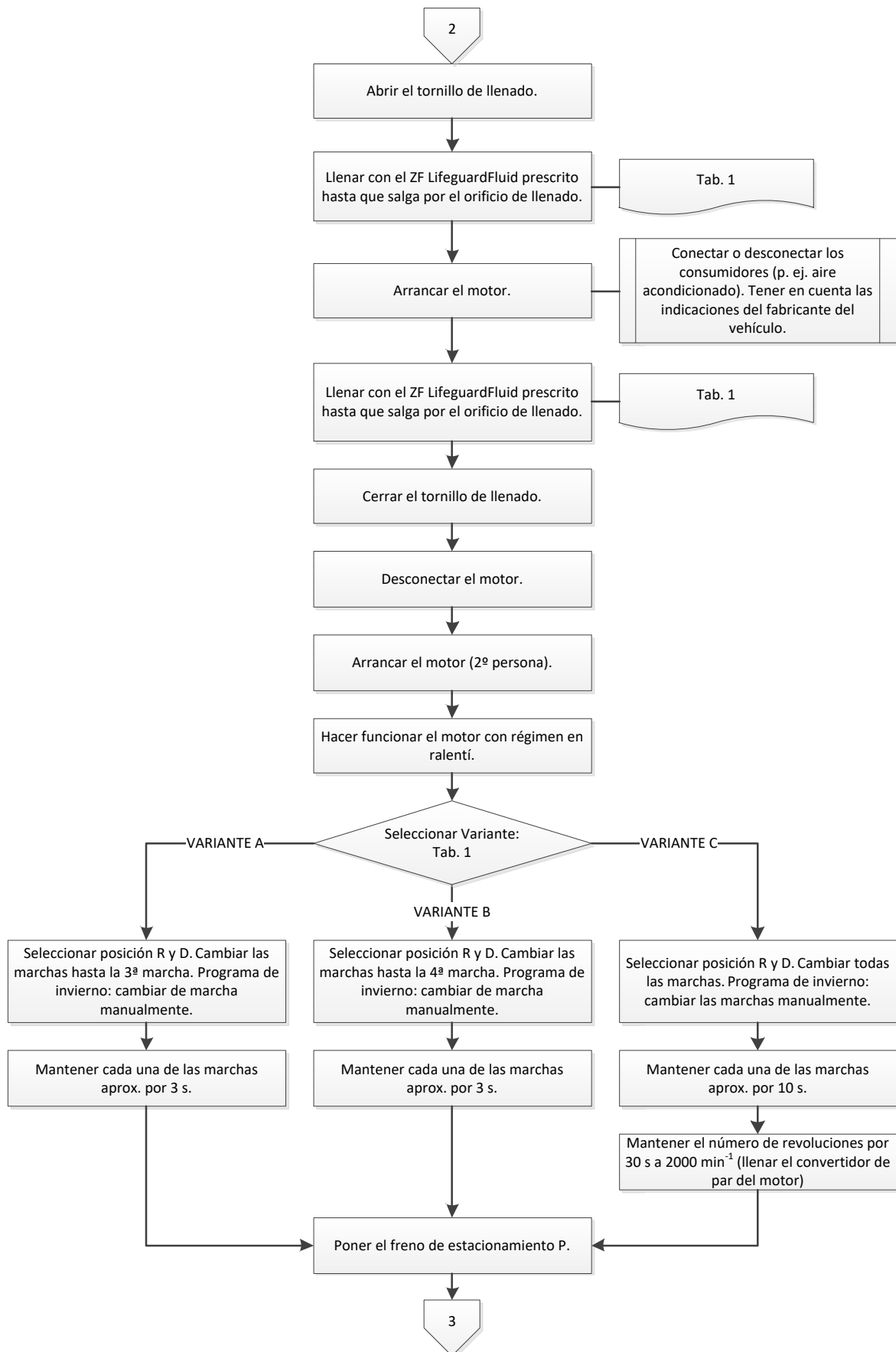



Montagehinweis
Mounting instruction
Instruction de montage
Indicación para el montaje

DE
EN → page 15
FR → page 20
ES → page 25

