

LEDDriving® SMART CANBUS

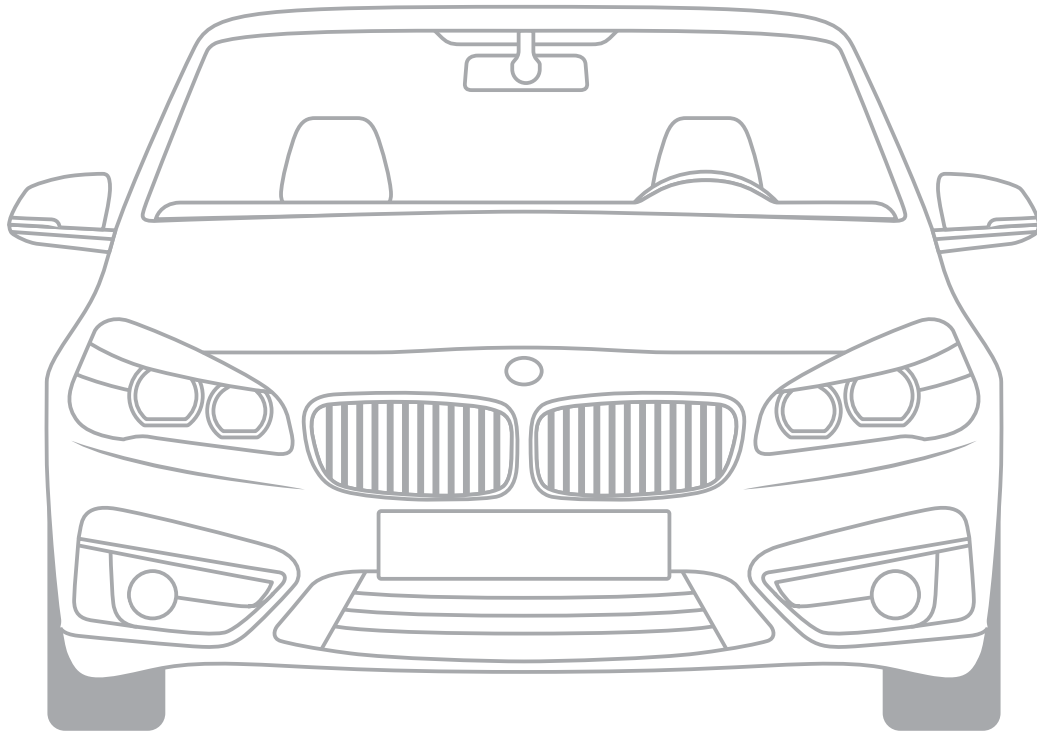

LEDSC03

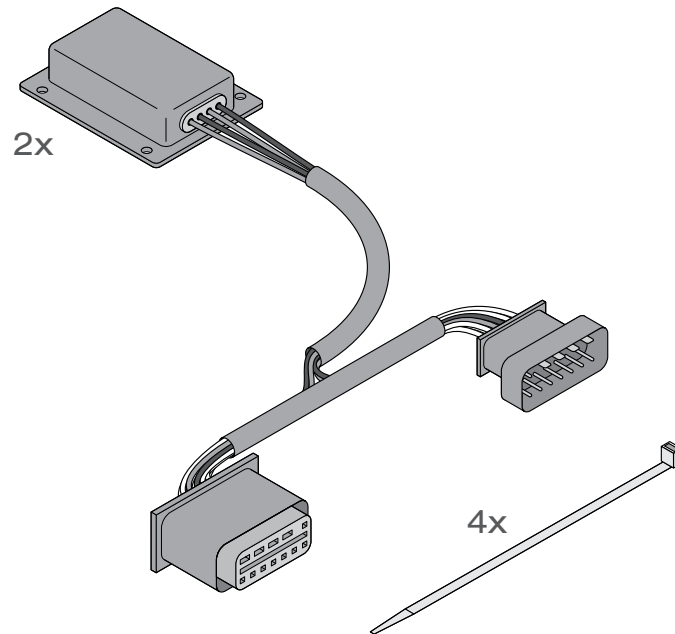

BMW 2er Active Tourer F45/46

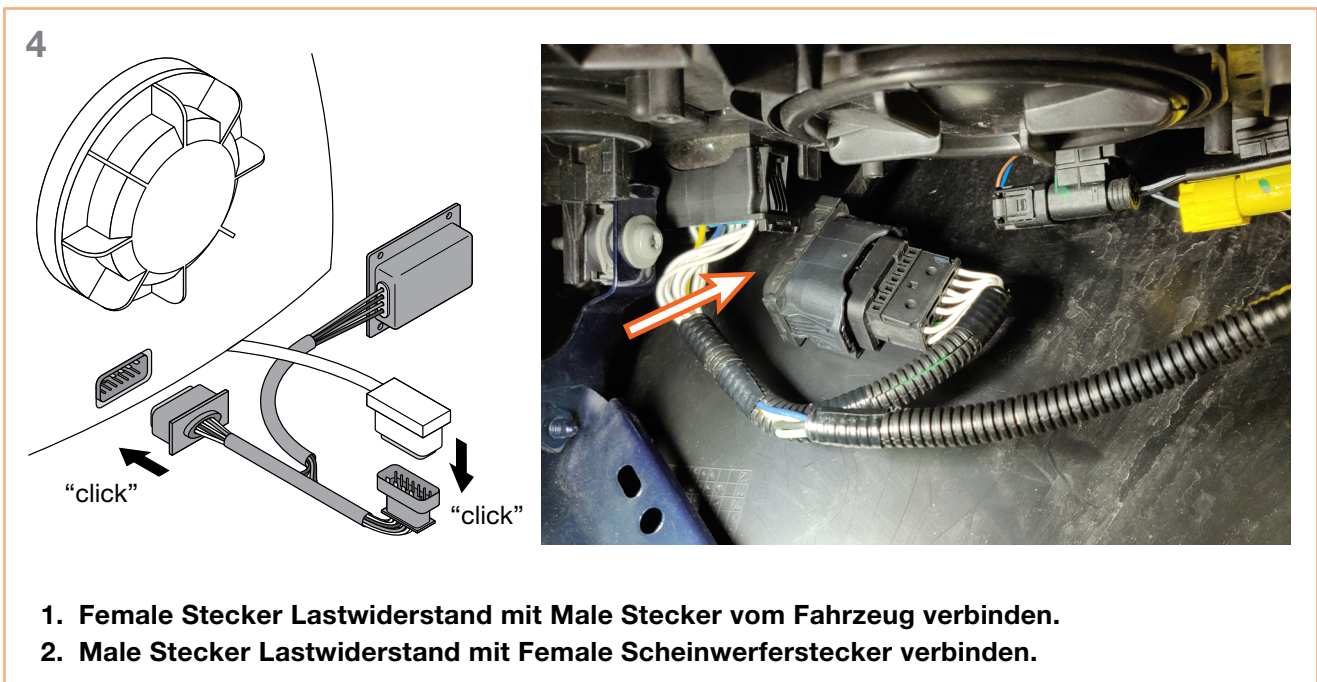
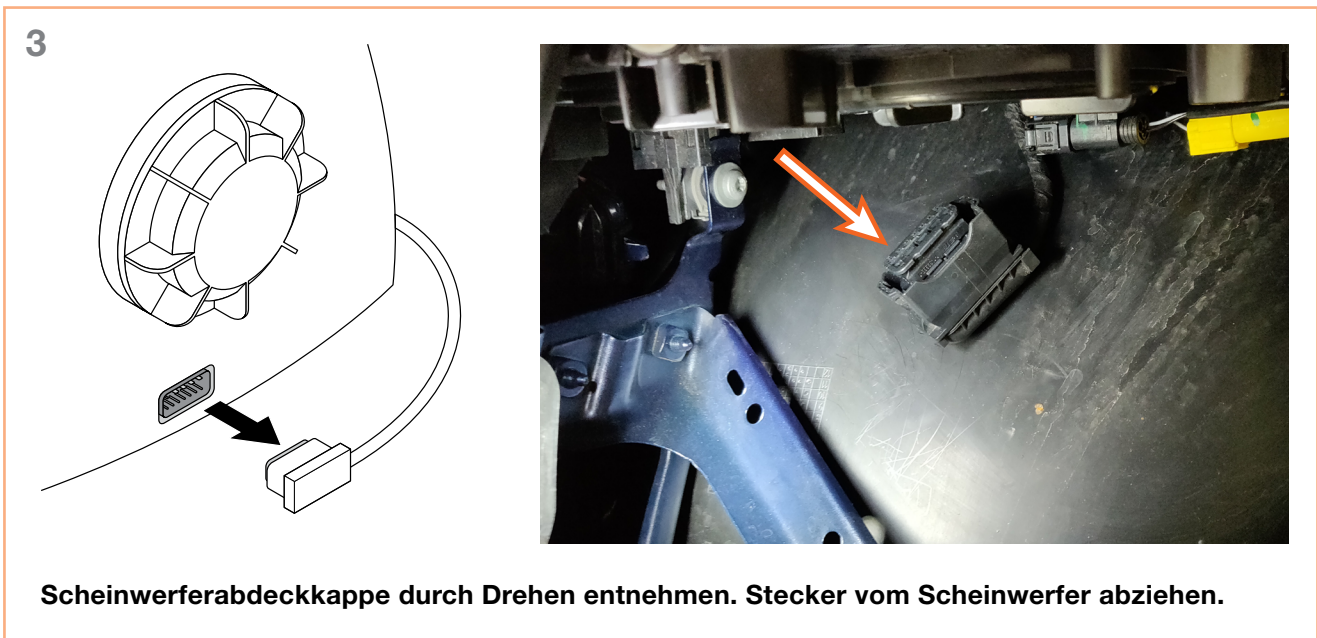
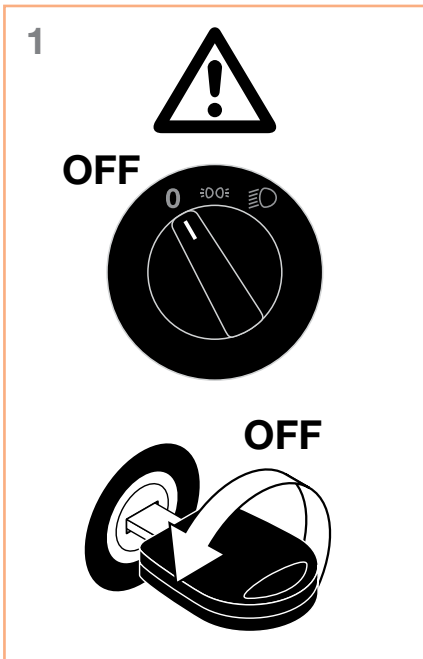

5

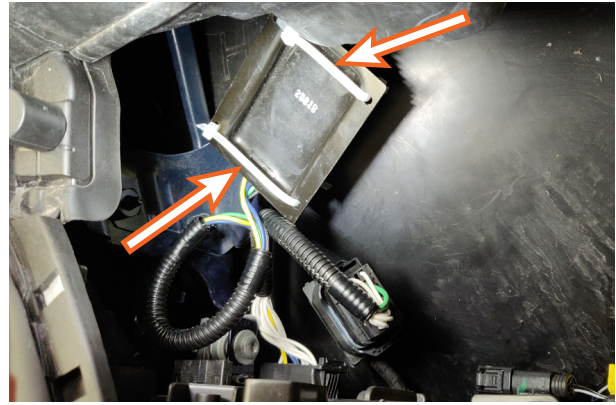
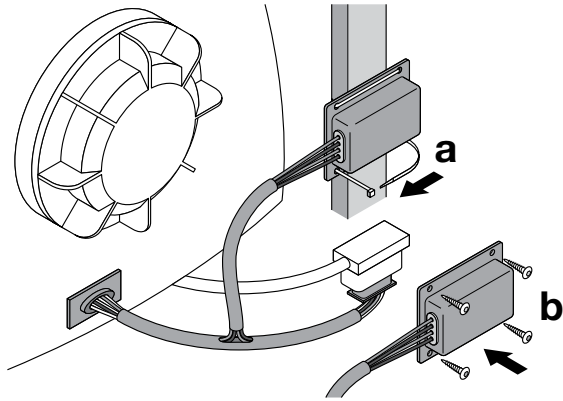

Canbus an Fahrzeugkarosserie mit Hilfe von Kabelbinder befestigen.
ACHTUNG: Kabelbinder stramm festziehen!

6

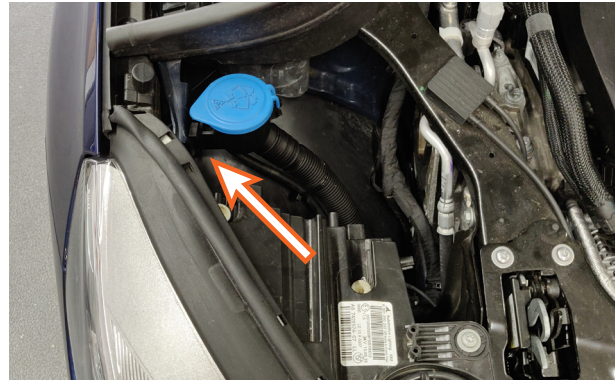
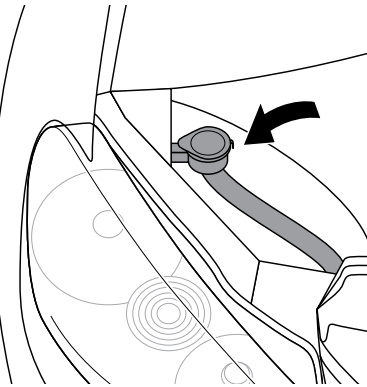

Spritzwasserfüllrohr wieder verbauen und Motorhaube schließen.

7

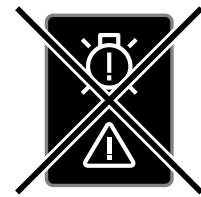
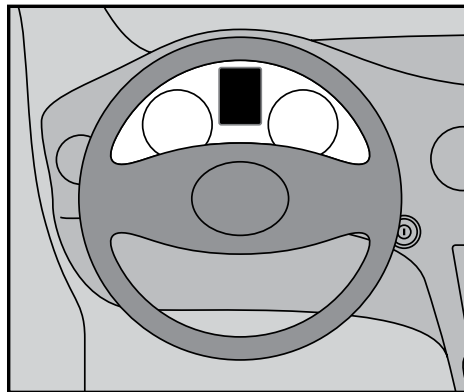
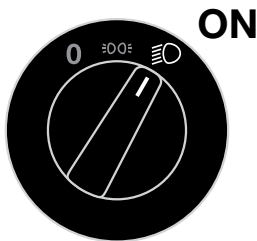

Empfehlung des Herstellers ist es, den Lichtquellenwechsel verbunden mit Anbringen des Lastwiderstandes von fachspezifischem Personal durchführen zu lassen!

Bei Fragen bzgl. Wartung oder technischen Problemen wenden Sie sich bitte an den OSRAM Kundendienst via automotive-service@osram.com